



# JASIC®

## EVO2.0



## Operator Manual

### EA-160 & EA-200

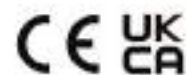

# Your new product



Jasic.co.uk

Thank you for selecting this Jasic EVO 2.0 product.

This product manual has been designed to ensure that you get the most from your new product. Please ensure that you are fully conversant with the information provided paying particular attention to the safety precautions. The information will help protect yourself and others against the potential hazards that you may come across.

Please ensure that you carry out daily and periodic maintenance checks to ensure years of reliable and trouble free operation.

Please call your Jasic distributor in the unlikely event of a problem occurring. Please record below the details from your product as these will be required for warranty purposes and to ensure you get the correct information should you require assistance or spare parts.

Date purchased \_\_\_\_\_

From where \_\_\_\_\_

Serial number \_\_\_\_\_

(The serial number is normally located on the top or underside of the machine and will begin with AA)

For further information on your Jasic product warranty registration please visit:

[www.jasic-warranty.co.uk](http://www.jasic-warranty.co.uk)

## **Disclaimer**

Whilst every effort has been made to ensure that the information contained within this manual is complete and accurate, no liability can be accepted for any errors or omissions.

## **Please Note:**

Products are subject to continual development and may be subject to change without notice. Regularly check our product pages at [www.jasic.co.uk](http://www.jasic.co.uk) for revision updated operating manuals.

No part of this manual may be copied or reproduced by any means without the written permission of Wilkinson Star Limited.

# CONTENTS

Index	Page
Your New Product	2
Index	3
Safety Instruction	4
General electrical safety	4
General operating safety	4
PPE	5
Welding processes lens shade selector guide	5
Fume and welding gases	6
Fire risks	6
The working environment	7
Protection from moving parts	7
Magnetic fields	7
Compressed gas cylinders and regulators	7
RF declaration	8
LF declaration	8
Materials and their disposal	9
Package and Contents	9
Description of Symbols	10
Product Overview	11
Technical Specifications	12
Description of Controls	13
Installation	14
Control Panel	16
Remote Control Option (wired and wireless)	20
MMA Setup	21
Operation MMA	22
Guide to MMA Welding	25
MMA Welding Troubleshooting	29
Operation LIFT TIG	30
Guide to TIG Welding	33
TIG Welding Troubleshooting	37
Maintenance	40
Troubleshooting	40
WEEE Disposal	42
RoHS Compliance Declaration	42
UKCA Declaration of Conformity	43
EC Declaration of Conformity	44
Statement of Warranty	45
Schematic	46
Options and Accessories	47
Notes	48
Jasic Contact Details	50

# SAFETY INSTRUCTIONS



These general safety norms cover both arc welding machines and plasma cutting machines unless otherwise noted. The user is responsible for installing and operating the equipment in accordance with the enclosed instructions.

It is important that users of this equipment protect themselves and others from harm, or even death. The equipment must only be used for the purpose it was designed for. Using it in any other way could result in damage or injury and in breach of the safety rules.

Only suitably trained and competent persons should operate the equipment.

Pacemaker wearers should consult their doctor prior to using this equipment.

PPE and workplace safety equipment must be compatible for the application of the work involved.

**Always carry out a risk assessment before carrying out any welding or cutting activity.**

## General electrical safety



The equipment should be installed by a qualified person and in accordance with current standards in operation.

It is the users responsibility to ensure that the equipment is connected to a suitable power supply. Consult your utility supplier if required.

Do not use the equipment with the covers removed. Do not touch live electrical parts or parts which are electrically charged. Turn off all equipment when not in use.

In the case of abnormal behaviour of the equipment, the equipment should be checked by a suitably qualified service engineer.

If earth bonding of the work piece is required, bond it directly with a separate cable with a current carrying capacity capable of carrying the maximum capacity of the machine current.

Cables (both primary supply and welding) should be regularly checked for damage and overheating.

Never use worn, damaged, under sized or poorly jointed cables.

Insulate yourself from work and earth using dry insulating mats or covers big enough to prevent any physical contact.

Never touch the electrode if you are in contact with the work piece return.

Do not wrap cables over your body.

Ensure that you take additional safety precautions when you are welding in electrically hazardous conditions such as damp environments, wearing wet clothing and metal structures.

Try to avoid welding in cramped or restricted positions.

Ensure that the equipment is well maintained. Repair or replace damaged or defective parts immediately.

Carry out any regular maintenance in accordance with the manufacturers instructions.

The EMC classification of this product is class A in accordance with electromagnetic compatibility standards CISPR 11 and IEC 60974-10 and therefore the product is designed to be used in industrial environments only.

**WARNING:** This class A equipment is not intended for use in residential locations where the electrical power is provided by a public low-voltage supply system. In those locations it may be difficult to ensure the electromagnetic compatibility due to conducted and radiated disturbances.

## General operating safety



Never carry the equipment or suspend it by the carrying strap or handles during welding.

Never pull or lift the machine by the welding torch or other cables.

Always use the correct lift points or handles. Always use the transport under gear as recommended by the manufacturer.

Never lift a machine with the gas cylinder mounted on it.

If the operating environment is classified as dangerous, only use S-marked welding equipment with a safe idle voltage level. Such environments may be for example: humid, hot or restricted accessibility spaces.

# SAFETY INSTRUCTION

## **CAUTION** Use of Personal Protective Equipment (PPE)

**PPE REQUIRED AT ALL TIMES** Welding arc rays from all welding and cutting processes can produce intense, visible and invisible (ultraviolet and infrared) rays that can burn eyes and skin.

- Wear an approved welding helmet fitted with an appropriate shade of filter lens to protect your face and eyes when welding, cutting or watching.
- Wear approved safety glasses with side shields under your helmet.
- Never use any equipment that is damaged, broken or faulty.
- Always ensure there are adequate protective screens or barriers to protect others from flash, glare and sparks from the welding and cutting area.
- Ensure that there are adequate warnings that welding or cutting is taking place.
- Wear suitable protective flame resistant clothing, gloves and footwear.
- Ensure adequate extraction and ventilation is in place prior to welding and cutting to protect users and all workers nearby.
- Check and be sure the area is safe and clear of flammable material before carrying out any welding or cutting.



Some welding and cutting operations may produce noise. Wear safety ear protection to protect your hearing if the ambient noise level exceeds the local allowable limit (e.g: 85 dB).

### Welding and Cutting Lens Shade Selector Guide

WELDING CURRENT	MMA ELECTRODES	MIG LIGHT ALLOY	MIG HEAVY METALS	MAG	TIG ALL METALS	PLASMA CUTTING	PLASMA WELDING	GOUGING ARC/AIR
10	8	10	10	10	9	11	10	10
15								
20	11							
30					11			
40	12							
60		12						
80			13					
100	13							
125		14						
150	14							
175		15						
200	15							
225		16						
250	16							
275		17						
300	17							
350		18						
400	18							
450		19						
500	19							

# SAFETY INSTRUCTION

## Safety against fumes and welding gases



The HSE have identified welders as being an 'at risk' group for occupational diseases arising from exposure to dusts, gases, vapours and welding fumes. The main identified health effects are pneumonia, asthma, chronic obstructive pulmonary disease (COPD), lung and kidney cancer, metal fume fever (MFF) and lung function changes.

During welding and hot cutting 'hot work' operations, fumes are produced which are collectively known as welding fume. Depending upon the type of welding process being performed, the resultant fume generated is a complex and highly variable mixture of gases and particulates. Regardless of the length of welding being carried out, all welding fume, including mild steel welding requires suitable engineering controls to be in place which is usually Local Exhaust Ventilation (LEV) extraction to reduce the exposure to welding fume indoors and where LEV does not adequately control exposure it should also be enhanced by using suitable respiratory protective equipment (RPE) to assist with protecting against residual fume.

When welding outdoors appropriate RPE should be used.

Prior to undertaking any welding tasks an appropriate risk assessment should be carried out to ensure expected control measures are in place.



An example of personal fume protection

Locate the equipment in a well-ventilated position and keep your head out of the welding fume.

Do not breathe in the welding fume.

Ensure the welding zone is well-ventilated and provision should be made for suitable local fume extraction system to be in place.

If ventilation is poor, wear an approved airfed welding helmet or respirator.

Read and understand the Material Safety Data Sheets (MSDS's) and the manufacturer's instructions for metals, consumable, coatings, cleaners and de-greasers.

Do not weld in locations near any de-greasing, cleaning or spraying operations.

Be aware that heat and rays of the arc can react with vapours to form highly toxic and irritating gases.

**For further information please refer to the HSE website [www.hse.gov.uk](http://www.hse.gov.uk) for related documentation.**

## Precautions against fire and explosion



Avoid causing fires due to sparks and hot waste or molten metal.

Ensure that appropriate fire safety devices are available near the welding and cutting area.

Remove all flammable and combustible materials from the welding, cutting and surrounding areas.

Do not weld or cut fuel and lubricant containers, even if empty. These must be carefully cleaned before they can be welded or cut.

Always allow the welded or cut material to cool before touching it or placing it in contact with combustible or flammable material.

Do not work in atmospheres with high concentrations of combustible fumes, flammable gases and dust.

Always check the work area half an hour after cutting to make sure that no fires have begun.

Take care to avoid accidental contact of the torch electrode to metal objects, as this could cause arcs, explosion, overheating or fire.

## **Know and understand your fire extinguishers**

	Water	Foam spray	ABC powder	Carbon dioxide	Wet chemical
Portable (used on fire extinguishers if they meet)					
Flammable liquids (A)	✓	✓	✓	✗	✓
Flammable gases (B)	✗	✓	✓	✓	✗
Flammable solids (C)	✗	✗	✓	✗	✗
Electrical (E)	✗	✗	✓	✓	✗
Cooking oil & fat (F)	✗	✗	✗	✗	✓

# SAFETY INSTRUCTION

## The working environment



Ensure the machine is mounted in a safe and stable position allowing for cooling air circulation.  
Do not operate equipment in an environment outside the laid down operating parameters.  
The welding power source is not suitable for use in rain or snow.

Always store the machine in a clean, dry space.

Ensure the equipment is kept clean from dust build up.

Always use the machine in an upright position.

## Protection from moving parts



When the machine is in operation keep away from moving parts such as motors and fans.

Moving parts, such as the fan, may cut fingers and hands and snag garments.

Protections and coverings may be removed for maintenance and managed only by qualified personnel after first disconnecting the power supply cable.

Replace the coverings and protections and close all doors when the intervention is finished and before starting the equipment.

Take care to avoid getting fingers trapped when loading and feeding wire during set up and operation.

When feeding wire be careful to avoid pointing it at other people or towards your body.

Always ensure machine covers and protective devices are in operation.

## Risks due to magnetic fields



The magnetic fields created by high currents may affect the operation of pacemakers or electronically controlled medical equipment.

Wearers of vital electronic equipment should consult their physician before beginning any arc welding, cutting, gouging or spot welding operations.

Do not go near welding equipment with any sensitive electronic equipment as the magnetic fields may cause damage.

Keep the torch cable and work return cable as close to each other as possible throughout their length.

This can help minimise your exposure to harmful magnetic fields.

Do not wrap the cables around the body.

## Handling of compressed gas cylinders and regulators



Mishandling gas cylinders can lead to rupture and the release of high pressure gas.

Always check the gas cylinder is the correct type for the welding to be carried out.

Always store and use cylinders in an upright and secure position.

**Danger**  
Compressed gas

All cylinders and pressure regulators used in welding operations should be handled with care.

Never allow the electrode, electrode holder or any other electrically “hot” parts to touch a cylinder.

Keep your head and face away from the cylinder valve outlet when opening the cylinder valve.

Always secure the cylinder safely and never move with regulator and hoses connected.

Use a suitable trolley for moving cylinders.

Regularly check all connections and joints for leaks.

Full and empty cylinders should be stored separately.

## Never deface or alter any cylinder

# SAFETY INSTRUCTIONS

## Fire awareness



The cutting and welding process can cause serious risks of fire or explosion. Cutting or welding sealed containers, tanks, drums or pipes can cause explosions. Sparks from the welding or cutting process can cause fires and burns. Check and risk assess the area is safe before doing any cutting or welding. Ventilate all flammable or explosive vapour from the workplace.

Remove any and all flammable materials away from the working area. If necessary, cover flammable materials or containers with approved covers (following manufacturers instructions) if unable to remove from the immediate area.

Do not cut or weld where the atmosphere may contain flammable dust, gas or liquid vapour. Always have the appropriate fire extinguisher nearby and know how to use it.

## Hot parts



Always be aware that material being cut or welded will get very hot and hold that heat for a considerably long time which will cause severe burns if the appropriate PPE is not worn. Do not touch hot material or parts with bare hands.

Always allow for a cooling down period before working on material recently cut or welded. Use the appropriate insulated welding gloves and clothing to handle hot parts to prevent burns.

## Noise awareness



The cutting and welding process can generate noise that can cause permanent damage to your hearing. Noise from cutting and welding equipment can damage hearing.

Always protect your ears from noise and wear approved and appropriate ear protection if noise levels are high.

Consult with your local specialist if you are unsure how to test for noise levels.

## RF Declaration



Equipment that complies with directive 2014/30/EU concerning electromagnetic compatibility (EMC) and the technical requirements of EN60974-10 is designed for use in industrial buildings and not for domestic use where electricity is provided via the low voltage public distribution system.

Difficulties may arise in assuring class A electromagnetic compatibility for systems installed in domestic locations due to conducted and radiated emissions.

In the case of electromagnetic problems, it is the responsibility of the user to resolve the situation.

It may be necessary to shield the equipment and fit suitable filters on the mains supply.

## LF Declaration



Consult the data plate on the equipment for the power supply requirements.

Due to the elevated absorbance of the primary current from the power supply network, high power systems affect the quality of power provided by the network. Consequently, connection restrictions or maximum impedance requirements permitted by the network at the public network connection point must be applied to these systems.

In this case, the installer or the user is responsible for ensuring the equipment can be connected, consulting the electricity provider if necessary.



# SAFETY INSTRUCTION

## Materials and their disposal



Welding equipment is manufactured with BSI published standards meeting CE requirements for materials which do not contain any toxic or poisonous materials dangerous to the operator. Do not dispose of the equipment with normal waste.



The European Directive 2012/19/EU on Waste Electrical and Electronic Equipment states that electrical equipment that has reached its end of life must be collected separately and returned to an environmentally compatible recycling facility for disposal.

**For more detailed information please refer to the HSE website [www.hse.gov.uk](http://www.hse.gov.uk)**

## PACKAGE CONTENTS AND UNPACKING

Supplied within your new Jasic EVO product package will be the following items with each model.

Use care when unpacking the contents and ensure all items are present and not damaged.

If damage is noted or items are missing, please contact the supplier in the first instance and before installing or using the product.

Record the product model, serial numbers and purchase date in the information section found on the inside front page of this operating manual.

### Jasic EVO Arc 160PFC

EA-160 PFC Power Source

MMA work lead

Work Return Lead

USB Stick with Operating Manual

### Jasic EVO Arc 200PFC

EA-200 PFC Power Source

MMA work lead

Work Return Lead

USB Stick with Operating Manual



**Please Note:** Package contents may vary depending on country location and package part number purchased

# DESCRIPTION OF SYMBOLS



Read this operation manual carefully before use.



Warning in operation.



Single-phase static frequency converter-transformer rectifier.

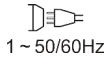

Symbol of single-phase AC power supply and rated frequency.



Can be used in the environment which has high risk of electric shock.

**IP** Degree of protection, such as IP23S.

**U<sub>1</sub>** Rated AC input voltage (with tolerance  $\pm 15\%$ ).

**I<sub>1max</sub>** Rated maximum input current.

**I<sub>1eff</sub>** Maximum effective input current.

**X** Duty cycle, The ratio of given duration time/the full-cycle time.

**U<sub>0</sub>** No-load voltage, Open circuit voltage of secondary winding.

**U<sub>2</sub>** Load voltage.

**H** Insulation class.



Do not dispose of electric waste with other ordinary waste. Protect our environment.



Electric shock risk warning.



Current unit "A"



Overheat protection indicator.



Overcurrent protection indicator.



VRD function indicator.



MMA mode.



LIFT TIG mode.

$\phi$  3.2

$\phi$  4.0

Selection of welding electrode diameter for MMA.



MMA current.



Hot start current of MMA.



Arc force of MMA.



Welding mode switching.



Other function switching.



Wireless indication.



Remote control.



Pairing of wireless remote controller.

## PRODUCT OVERVIEW

This is a digital inverter DC manual welder featuring advanced technology which provides excellent performance. It provides a stable DC arc and can weld carbon steel, low alloy steel, stainless steel and other materials. Moreover, the EVO 2.0 unit offers adjustable hot start and arc force functions that ensures it's a durable machine for a wide range of applications.

With DC MMA and LIFT TIG processes, it can be widely used in precise welding of an extensive range of materials. The unique electrical structure and air passage design inside the machine increases the dissipation of heat generated by power devices, thus improving the duty cycle of the machine. Benefitting from the unique air passage, the equipment can effectively prevent damage to power devices and control circuits from dust drawn in by the fan, thus greatly improving the reliability of the equipment.

The unique ClearVision display offers the operator clear and informative data for the welding process offered.



### The main functions are:

- Two welding processes: DC MMA and LIFT TIG.
- Current settings, Arc force and Hot start current are displayed for more accurate adjustment.
- Anti-stick function: prevents the welding electrode from sticking to the work piece during welding.
- Synergic function: MMA current can be automatically set to match the selected electrode diameter, making operator welder setting easier.
- MMA Hot start function: makes MMA arc ignition easier and more reliable arc starting, low spatter, stable current which offers good weld bead shape.
- On-demand fan: Prolongs the life span of the internal fan and reduce the accumulation of grinding dust etc. inside the machine.
- Parameters are automatically saved before shutdown, and the settings are restored after starting again.
- Parameter factory reset option.
- Wired remote control interface as standard via front panel mounted 3 pin socket
- Optional wireless remote control is available.
- Inbuilt power factor correction (PFC). With power factor correction, the power factor is the ratio of true power (KW) divided by reactive power (kvar). Power factor value is between 0.0 and 1.00 and if the power factor exceeds 0.8, the device is using mains input power efficiently
- Wide Voltage mains input, this technology allows these to fully operate on mains input supplies seamlessly between 95V – 265V AC with inbuilt auto compensation for mains voltage fluctuation
- ClearVision digital control panel
- Excellent weld characteristics
- Heavy duty 35-50mm dinse sockets
- Suitable for a wide range of electrodes
- Generator friendly
- High quality finish to mouldings and handle

# TECHNICAL SPECIFICATIONS

Parameter	Unit	Jasic Arc EA-160 PFC	Jasic Arc EA-200 PFC
Rated input (U1)	V & Hz	AC 95 ~ 265V 50/60	AC 95 ~ 265V 50/60
Rated input current (I <sub>eff</sub> )	A	115V - MMA 14.4 115V - TIG 11.7 230V - MMA 11.3 230V - TIG 7	115V - MMA 15.6 115V - TIG 13.6 230V - MMA 14.9 230V - TIG 9.8
Rated input current (I <sub>max</sub> )	A	115V - MMA 28.7 115V - TIG 23.3 230V - MMA 22.6 230V - TIG 14	115V - MMA 31.2 115V - TIG 27.2 230V - MMA 29.7 230V - TIG 19.6
Rated input power	kVA	115V - MMA 3.3 115V - TIG 2.7 230V - MMA 3.2 230V - TIG 5	115V - MMA 3.6 115V - TIG 3.2 230V - MMA 6.8 230V - TIG 4.5
Welding current range	A	115V - MMA 20 ~ 110 115V - TIG 10 ~ 120 230V - MMA 20 ~ 160 230V - TIG 10 ~ 160	115V - MMA 20 ~ 120 115V - TIG 10 ~ 160 230V - MMA 20 ~ 200 230V - TIG 10 ~ 200
Welding voltage range (U <sub>2</sub> )	V	115V MMA 20.4 ~ 24.4 115V TIG 10.4 ~ 14.8 230V MMA 20.4 ~ 26.4 230V TIG 10.4 ~ 16.4	115V MMA 20.4 ~ 24.8 115V TIG 10.4 ~ 16.4 230V MMA 20.4 ~ 28.0 230V TIG 10.4 ~ 18.0
Rated duty cycle (X) (rated at 40°C)	%	MMA - 160A @ 25% TIG - 160A @ 25%	MMA - 200A @ 25% TIG - 200A @ 25%
Arc force range	A	0 ~ 60	0 ~ 60
Hot start range	A	0 ~ 60	0 ~ 60
No load voltage (OCV) (U <sub>0</sub> )	V	78	78
VRD voltage	V	11	11
Arc start mode	-	Contact	Contact
Efficiency	%	85	86
Idle State Power	W	< 50	< 50
Power factor	cosφ	0.99	0.99
Standard	-	EN60974-1	EN60974-1
Protection class	IP	IP23S	IP23S
Insulation class	-	H	H
Noise	Db	< 70	< 70
Operating Temperature range	°C	-10 ~ +40	-10 ~ +40
Storage temperature	°C	-25 ~ +55	-25 ~ +55
Size (with handle)	mm	413 x 150 x 311	413 x 150 x 311
Net weight	Kg	7.2	7.2
Overall weight	Kg	9	9

## Please Note

Due to variations in manufactured products all claimed performance ratings, capacities, measurements, dimensions and weights quoted are approximate only. Achievable performance and ratings when in use can depend upon correct installation, applications and use along with regular maintenance and service.

# DESCRIPTION OF CONTROLS

## Front view Jasic Arc EA-160 and EA-200

1. Machine carry handle
2. Digital user control panel (see lower down for further information)
3. Wireless remote control (optional)
4. "+" Output terminal, The connection for the electrode holder in MMA mode
5. "-" Output terminal\*: The connection for the work clamp in MMA mode
6. Wired remote control 3 pin socket
7. Input power cable

\* Panel socket size is 35/50mm

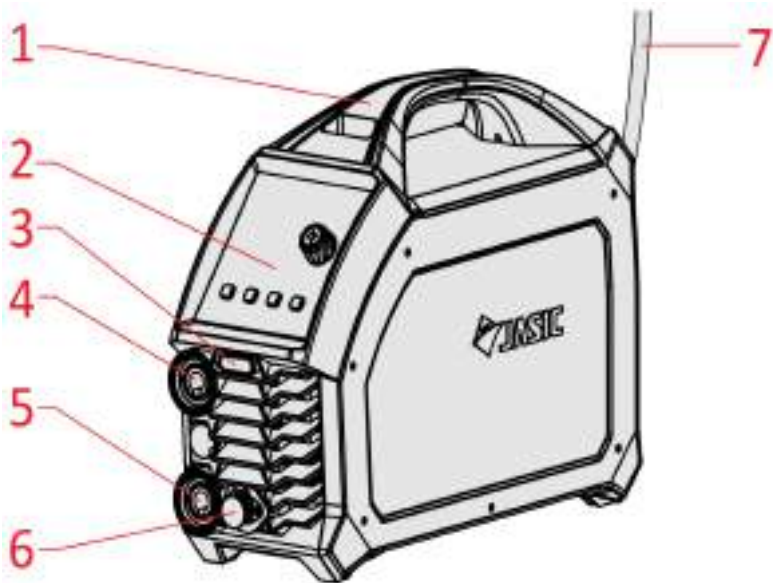

## Rear view Jasic EA-160 and EA-200

8. Carry handle
9. ON/OFF power switch
10. Rear panel with integrated cooling vents
11. Input power cable

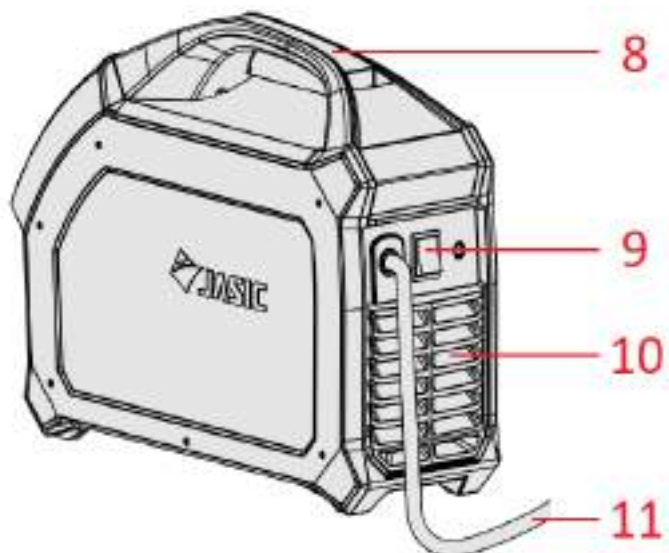

## Front control panel view Jasic Arc EA-160 and EA-200



12. Parameter and error code display
13. Warning indicators
14. Operation mode selector
15. electrode diameter selector
16. VRD function indicator
17. Parameter adjustment knob
18. MMA parameter selection
19. Remote control enable selector and indicator (optional) \*

\* Some model versions may not have this feature and the indicator will not be 'ON' during operation.

# INSTALLATION

## Unpacking

Check the packaging for any signs of damage.

Carefully remove the machine and retain the packaging until the installation is complete.

## Location

The machine should be located in a suitable position and environment.

Care should be taken to avoid moisture, dust, steam, oil or corrosive gases.

Place on a secure level surface and ensure that there is adequate clearance around the machine to ensure natural airflow.

## Warning!



**The following operation requires sufficient professional knowledge on electric aspects and comprehensive safety knowledge.**

**All connections shall be made with the power supply turned off.**

**Incorrect input voltage may damage the equipment.**

**Electric shock may cause death; after power switch off, there is still a high voltage within the machine, do not touch any of the live parts on the equipment.**

**This product meets the requirements of Class A equipment in EMC requirements and is not to be connected to a residential low-voltage power supply grid.**

## Input power connection

Before connecting the machine you should ensure that the correct supply is available.

Details of the machine requirements can be found on the data plate of the machine or in the technical parameters shown in the manual.

The equipment should be connected by a suitably qualified competent person.

Always ensure the equipment is correctly grounded.

## Warning!



**Never connect the machine to the mains supply with the panels removed. The electrical connection of this equipment shall be carried out by suitably qualified personnel and these shall be made with the power supply off. Incorrect voltage may damage the equipment.**

1. Test with multi-meter to ensure the input voltage value is within the specified input voltage range.
2. Ensure that the power switch of the welder is turned off.
3. Wire the input mains cable wires to the correct sized mains plug, ensuring that the live, neutral and earth wires are connected correctly.
4. Ensure that the mains supply fusing is correctly rated for the connected machine.
5. Connect the machine mains power plug firmly to the corresponding supply socket.

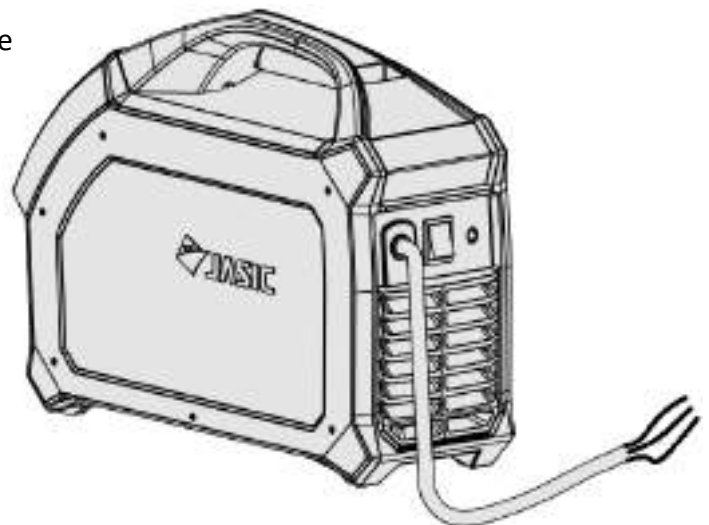

## Please Note!

If the machine needs to be operated on long extension leads, then please use an extension lead where the cable has a larger cross-sectional area to reduce the voltage drop, please consult your electrician or electrical supplier for the recommended size.

## INSTALLATION OF WIRED REMOTE CONTROL (STANDARD)

### Wired hand-held remote-control connection

As standard the EVO ARC 160 and 200 machines are fitted with a 3 pin remote control socket (1). This allows for the matching 3 pin plug (2) of the hand held remote control to be connected directly to the machine to offer the user remote operation control.

#### PLEASE NOTE:

Check that the machine supports a wired hand-held remote control before installation.

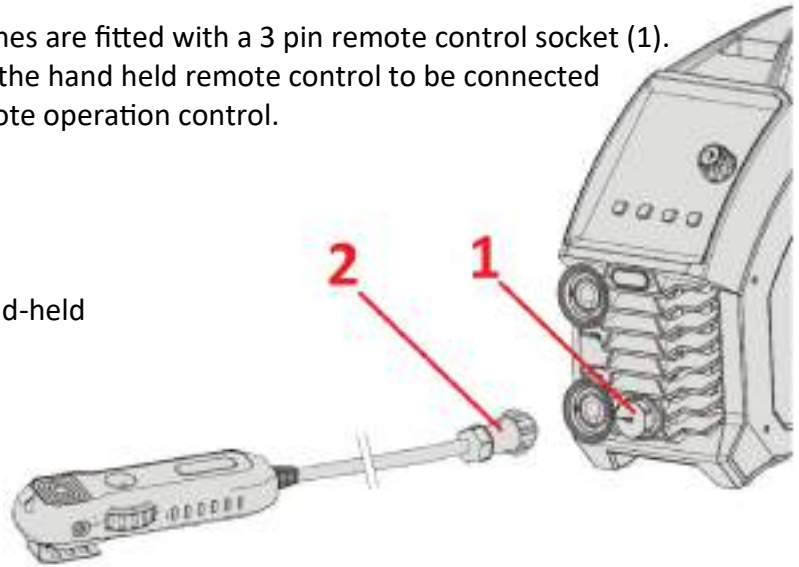

## WIRELESS REMOTE CONTROL (OPTIONAL)

### Wireless hand-held remote-control connection

An option with the EVO ARC range of machines is for the operator to be able to wirelessly control the welding current. To enable wireless, you will require to fit the optional remote interface module.

#### Installation of the wireless receiver module

- 1) Remove the plastic cap 'A' shown in the image right and fit the wireless receiver module as shown.
- 2) Remove the screws of the left side cover of the machine.
- 3) Remove the buckle from inside the front panel of the machine and pull out the plug.
- 4) Insert the wireless receiver module 'B' to the front panel, and then connect the connection line of the receiver module to the CN5 socket on the main board.

#### PLEASE NOTE:

Please check that the machine supports wireless hand held remote controls before installation.

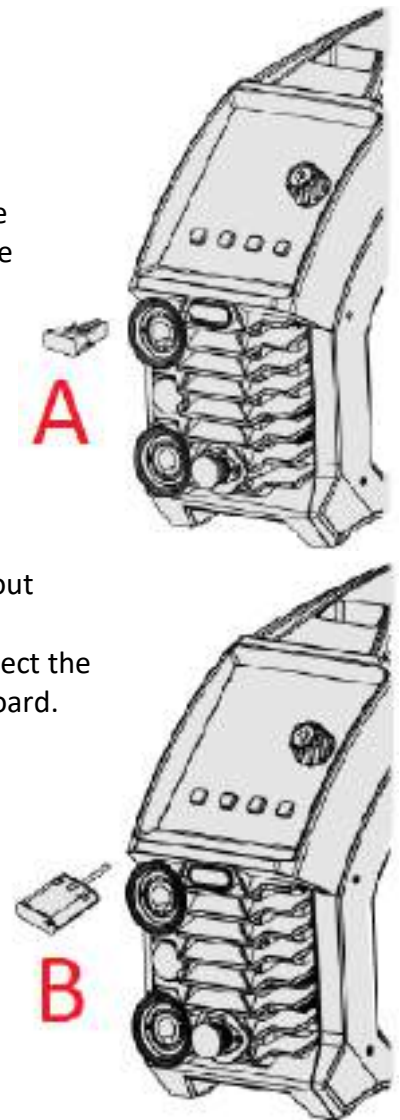

The above operation requires sufficient professional comprehensive knowledge of electrical circuits and electrical safety. Make sure the input cable of the machine is disconnected from the electricity supply and wait for 5 minutes before removing the machine covers.

## FRONT PANEL DISPLAY

1. Digital meter: Displays pre-set and actual current as well as displaying the parameter adjustment settings along with error codes (see below).
2. Warning indicator: The yellow warning LED will light up if the machine overheats, the red warning LED will illuminate if the machine experiences an input mains under or over voltage situation.
3. MMA/TIG selector and indicators: Allows the operator to switch between MMA and TIG welding mode.
4. Electrode diameter selector: Using this selection button allows the user to switch between various welding electrode sizes.
5. VRD indicator: The VRD (Voltage Reduction Device) LED will be lit when the machine is in MMA mode and the VRD function is enabled.
6. Parameter adjustment dial: Depending on the selected parameter, the operator can rotate the control dial which allows the selected parameter to be adjusted via the digital display.
7. MMA parameter selection zone: By pressing the MMA parameter button you will have access to adjust MMA welding current, MMA hot start and MMA arc force control.
8. Remote control (optional)\* : Pressing the remote button will firstly illuminate the remote control indicator LED which indicates that the remote current control has activated, so a hand held amperage device can be used. Pressing the remote button again will then allow amperage control to function from the control panel via control dial 6 (as above).





\* The standard panel version does not have the key, so the indicator will not be 'ON' during welding

### Display of parameters and error codes

- 1) When the machine is not welding, the current parameter pre-set value will be automatically displayed.
- 2) When the machine is welding, the 'actual' output current value is displayed.
- 3) When the factory settings are restored the countdown time for restore is displayed.
- 4) If the serial number is required, the serial number can be called up and shown on the display.
- 5) When the machine incurs a fault, an error code relating to the fault will be displayed .



### Welding mode selection

- 1) Upon switch ON, press the welding mode button  to switch between the MMA and Lift TIG welding options and select the corresponding mode based on your required welding process.
- 2) When the indicator  light is on, this indicates that MMA mode is selected.
- 3) When the indicator  light is on, this indicates that TIG mode is selected .





## CONTROL PANEL

### Selection of welding electrode diameter for MMA





- 1) In MMA mode, press the electrode diameter selection button  to select the welding electrode diameter in manual mode and synergic mode.
- 2) The indicator  $\phi \bullet \bullet \bullet$  is ON, indicating that manual mode is selected and welding current is set and adjusted manually.
- 3) If either  $\phi 2.5$  mm,  $\phi 3.2$  mm or  $\phi 4.0$  mm indicator is ON, this indicates that the electrode diameter synergic mode is selected.



### PLEASE NOTE:

In the Synergic mode, the optimal welding parameters are automatically selected based on the electrode diameter, and the welding current is fine-tuned by adjusting the knob and other parameters are not adjustable.

### Selection of MMA parameters

- 1) When in MMA mode and manual mode, the parameters of welding current, hot start current and arc force can be selected by pressing the button  of MMA parameter selection.
- 2) If the indicator  light is ON, welding current is now accessible and welding current can be set or adjusted by rotating the control dial.
- 3) If the indicator  light is on, the hot start current parameter is now selected and hot start current can be adjusted and set by rotating the control dial.
- 4) If the indicator  light is on, arc force current parameter is now selected and arc force can now adjusted and set by rotating the control dial.



### PLEASE NOTE:

- During selection if the machine panel is untouched for a short period, it will automatically return to the welding current parameter setting.
- If the machine is left switched on and not used for a period of time, it will automatically go into sleep mode (low power mode).

# CONTROL PANEL

## LIFT TIG mode parameter setting

In the LIFT TIG welding mode, rotate the adjusting knob to set the current parameter.

### Protection indicators





When the overheat indicator is on, this indicates that the welder has overheated and output voltage ceases. When the welder cools, the indicator will go out and welding can recommence.



When the overcurrent indicator is on, this indicates that the welder has entered the overcurrent protection mode and the welder stops producing welding output. Turn off the machine and back on again to recommence welding.

### VRD (Voltage Reduction Device) function indications

- 1) When the VRD function is not enabled, the VRD indicator light is off.
- 2) When the VRD function is enabled, the VRD indicator displays green and no welding is performed, indicating that the VRD function is normal. 
- 3) When the VRD function is enabled and no welding is performed the VRD indicator light displays red, indicating that the VRD function is abnormal. 
- 4) When the VRD function is enabled the VRD indicator is not on during welding.

### Barcode display (Serial Number)

Before welding, press the welding mode key  and the parameter adjustment knob for 3 seconds to display the machines barcode serial number.

Pressing any key or rotating the encoder you will exit the barcode display. If you do not perform any operation on the panel, the barcode display automatically clears after 20 seconds.

### Restore factory settings



- 1) Before welding, press the welding mode  key for 5 seconds to return to factory defaults.
- 2) After pressing and holding for 1 second, the display window starts to count down from 3, when the countdown ends, and the factory settings are restored. If the button is released before the count down completes the factory reset procedure will not take place.
- 3) Factory defaults: MMA current from first power up is 80A and TIG current is 80A.

# CONTROL PANEL - FUNCTIONS

## Wired (Foot pedal / hand-held) Remote Control

A 3 pin remote control socket is fitted as standard to the front panel of the machine, (see page 47 for optional remote controls)





- 1) Before welding, press the remote-control function  button to enable the remote control function.
- 2) The indicator  will be lit indicating that the remote-control function is enabled.  
If the remote controller is connected, the remote control device controls the welding current.  
If no remote controller is connected then the welding current is controlled by the panel control dial.
- 3) If the indicator  is not lit, this indicates that the remote-control function is not active and welding current is controlled by the front panel control dial.



## Wireless Remote Control (optional)

(Wireless remote control interface is optional, see page 47 for remote options)



### 1) Wireless pairing connection

Before welding, press and hold the panel remote control function button  and the pairing button  of the wireless remote controller at the same time, hold for 2 seconds to perform wireless remote control pairing.



During pairing, the blue indicator of wireless receiver module  flashes, after successful pairing, the indicator  of remote control mode is on .

At the same time the blue indicator of wireless receiver module  will be constant on and the welder display window displays "OK".

After successful pairing, the welding current can be adjusted by "+" or "-" buttons on the wireless remote controller.

The range of current is from the machines minimum to the maximum current value which was previously displayed as preset current on the panel.

### 2) Disconnecting the wireless connection

After the remote controller is successfully paired, press the remote control function button  on the panel or the pairing button  of the wireless remote controller for 2 seconds, and the wireless connection of the remote controller will be disconnected.

After disconnecting the display window of the welder displays the character "FAL", and the green indicator of the wireless receiver module  will be constantly on.

## REMOTE CONTROL SOCKET

The Jasic Arc EA-160 and EA-200P are fitted with 3 pin remote control socket located on the front panel which is used to connect various MMA remote control devices.

3 Pin Remote socket configuration	
Pin No	Description
1	Potentiometer (min)
2	Potentiometer 10K (wiper)
3	Potentiometer (max)

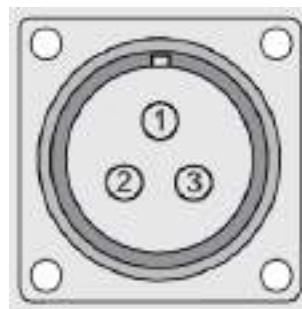

When fitting the 3 pin remote plug, ensure you align the keyway when inserting the plug into the socket, then rotate the rotating threaded collar fully clockwise until finger tight which secures the plug in place.

### Remote device activation

As with the previous page, to activate remote, press the remote button and the remote LED will illuminate (as shown right), this indicates that the machine is ready to be used with a remote control device.

Pressing the remote button again will turn the remote control function OFF and welding current will be controlled via the machines front control panel.



# MMA SETUP

## Output connections

Electrode polarity is generally determined by the type of welding rod being used although in general when using manual arc welding electrodes the electrode holder is connected to the positive terminal and the work return to the negative terminal.

Generally, there are two connection methods of DC welder: DCEN and DCEP connection.

DCEN: The welding electrode holder is connected to the negative polarity, and the workpiece is connected to the positive polarity.

DCEP: The electrode holder is connected to the positive polarity, and the workpiece is connected to the negative polarity.

The operator can choose DCEN based on the base metal and welding electrode.

Generally speaking, DCEP is recommended for basic electrodes (i.e. electrode connected to the positive polarity).

Always consult the electrode manufacturer's data sheet if you have any doubts.

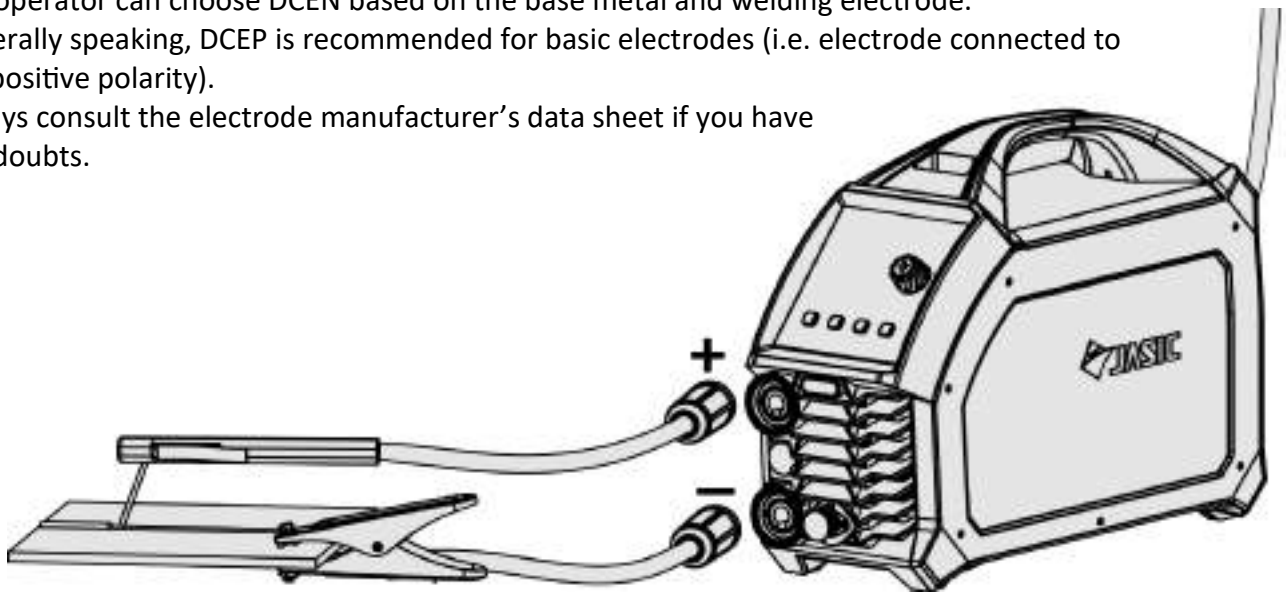

## MMA welding

1. When connecting welding cables, ensure that the machine's ON/OFF mains switch is turned off and never connect the machine to the mains supply with the panels removed.
2. Insert the cable plug with electrode holder into the "+" socket on the front panel of the welding machine and tighten it clockwise.
3. Insert the cable plug of the work return lead into the "-" socket on the front panel of the welding machine and tighten it clockwise.

If you want to use long secondary cables (Electrode holder cable and/or earth cable), you must ensure that the cross-sectional area of the cable is increased appropriately in order to reduce the voltage drop due to the cable length.

### Please Note:

Check these power connections daily to ensure they have not become loose otherwise arcing may occur when used under load.

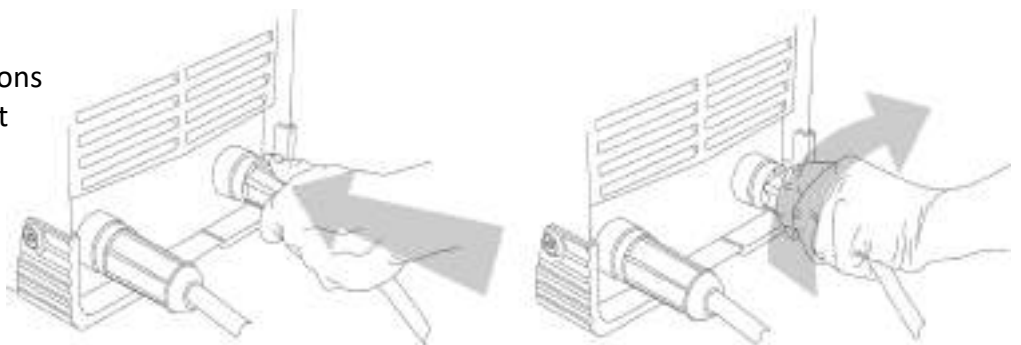

Generic library picture

## OPERATION - MMA



Before starting any welding activity ensure that you have suitable eye protection and protective clothing. Also take the necessary steps to protect any persons within the welding area.

### MMA welding

MMA (Manual Metal Arc), SMAW (Shielded Metal Arc Welding) or just Stick Welding. Stick welding is an arc welding process which melts and joins metals by heating them with an arc between a covered metal electrode and the work.

Shielding is obtained from the electrode outer coating, often called flux. Filler metal is primarily obtained from the electrode core.

The electrodes outer coating called flux assists in creating the arc and provides a shielding gas and on cooling forms a slag covering to protect the weld from contamination.

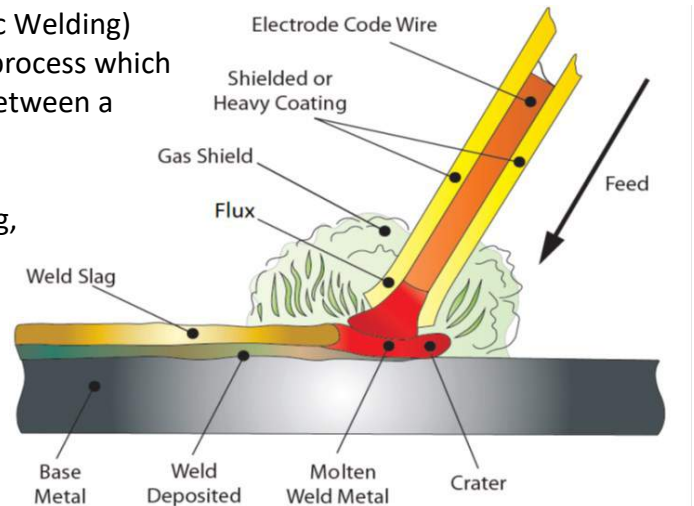

When the electrode is moved along the work piece at the correct speed the metal core deposits a uniformed layer called the weld bead.

After connecting the welding leads as detailed above, plug your machine into the mains supply and turn the machine 'ON', the power switch is located on the rear panel of the machine, place it to the "ON" position, the panel indicator will then light up, the fan may start to rotate as the welding machine powers up and the control panel will also light up to indicate that the machine is ready to use as shown below.



Caution, there is voltage output at both output terminals.

#### PLEASE NOTE:

Some welding models are equipped with the smart fan function. When the power supply is turned on after a period before welding starts, the fan will automatically stop running. The fan will then run automatically when welding begins.

Now you can connect the welding leads as shown in the image below, ensure you check that you have the electrode polarity correct to match the welding rod specifications.

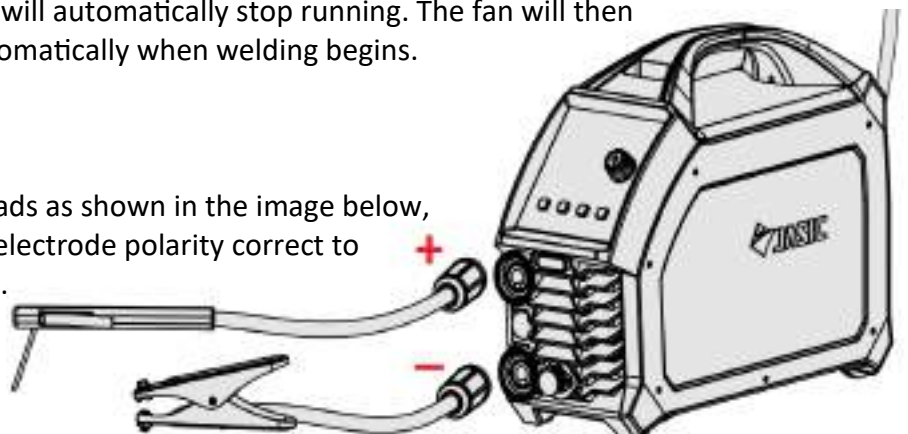

## OPERATION - MMA



Before starting any welding activity ensure that you have suitable eye protection and protective clothing as, welding rays, spatter, smoke and high temperatures produced in the process may cause injury to personnel.

Also take the necessary steps to protect any persons within the welding area that may cause injury to.

### MMA welding

Select MMA welding mode.



Welding current adjustment

Set the welding parameters when selecting the Manual mode.



Hot start adjustment



Arc force adjustment

The control knob can adjust welding current, hot start current and arc force parameters respectively.

### Selecting Synergic mode and setting the welding parameters.



After selecting the electrode diameter the system will automatically select the welding current, hot start current, and arc force. Users can rotate the adjuster knob according to the welding requirements to fine-tune the welding current parameters.

The table below gives a guide to set up for various welding electrode diameters versus recommended current range .

The operator can set their own parameters based on the type and diameter of welding electrode and their own process requirements.

Electrode Diameter (mm)	Recommended Welding Current (A)
1.0	20 ~ 60
1.6	44 ~ 84
2.0	60 ~ 100
2.5	80 ~ 120
3.2	108 ~ 148
4.0	140 ~ 180
5.0	160 ~ 250

#### PLEASE NOTE:

The operator should set the parameters that meet the welding requirements.

If the selections are incorrect this may lead to problems such as an unstable arc, spatter or sticking of the welding electrode to the work piece.

## OPERATION - MMA



Before starting any welding activity ensure that you have suitable eye protection and protective clothing as, welding rays, spatter, smoke and high temperatures produced in the process may cause injury to personnel.

Also take the necessary steps to protect any persons within the welding area that may cause injury.

### MMA welding

#### Arc force:

Arc force prevents the electrode sticking when welding. Arc force provides a temporary increase in current when the arc is too short and helps maintain consistent excellent arc performance on a wide range of electrodes. The Arc force value should be determined according to welding electrode diameter, current setting, and process requirements. High arc force settings lead to a crisper, higher penetration arc but with some spatter. Lower arc force settings provide a smooth arc with lower spatter and a good weld seam formation, but sometimes the arc is soft or the welding electrode can stick.

#### Hot start current:

The hot start current is an increase in welding current at the start of the weld to give excellent arc ignition and to avoid the electrode sticking. It also can reduce weld defects at the start of the weld.

The magnitude of hot start current is generally determined based on the type, specification, and welding current of welding electrode.

During DC welding the heat on the positive and negative electrodes of the welding arc is different. When welding using DC power supply, there are DCEN (DC electrode negative) and DCEP (DC electrode positive) connections. The DCEN connection refers to the welding electrode connected to the negative electrode of the power supply and the work piece connected to the positive electrode of the power supply.

In this mode the work piece receives more heat, resulting in high temperature, deep molten pool, easy to weld through, suitable for welding thick parts. The DCEP connection refers to the welding electrode connected to the positive power supply with the work piece connected to the negative power supply. In this mode the work piece receives less heat, resulting in low temperature, shallow pool, and difficulty in welding through. This is suitable for welding thin parts.

#### During welding:

NOTE! This unit has anti-stick function by default. In the welding process, if short circuit occurs for 2 seconds, it will automatically enter anti-stick function. This means the welding current will automatically drop to 20A to allow the short circuit to be cleared. When the short circuit is cleared the welding current will automatically return to the set current.

#### Turn off the power supply after welding

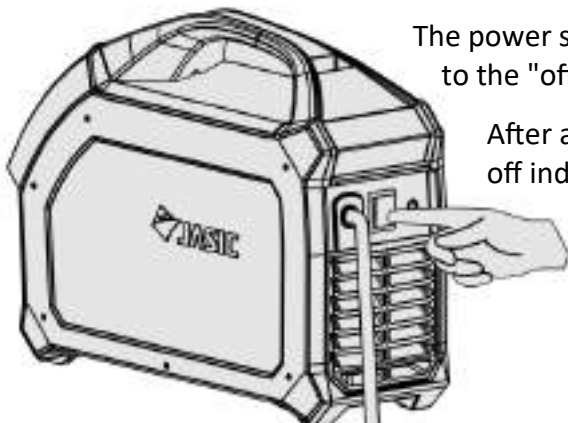

The power switch is located on the rear panel of the machine and set it to the "off" position.

After a short time delay, the control panel lights indicator will turn off indicating that the welder has powered down.



# GUIDE TO MMA WELDING



**Before starting any welding activity ensure that you have suitable eye protection and protective clothing. Also take the necessary steps to protect any persons within the welding area.**

## Notes for the welding beginner

This section is designed to give the beginner who has not yet done any welding some information to get them going. The simplest way to start is to practice by running weld beads on a piece of scrap plate. Start by using mild steel (paint free) plate of 6.0mm thick and using 3.2mm electrodes.

Clean any grease, oil and loose scale from the plate and fix firmly to your work bench so that welding can be carried out. Make sure that the work return clamp is secure and making good electrical contact with the mild steel plate, either directly or through the work table. For best results always clamp the work lead directly to the material being welding, otherwise a poor electrical circuit may create itself.

## Welding position

When welding, ensure you place yourself in a comfortable position for welding and your welding application before you begin to weld. This maybe be sitting at a suitable height which often is the best way to weld ensuring you're relaxed and not tense. A relaxed posture will ensure the welding task becomes much easier.

Please ensure you always wear suitable PPE and use suitable fume extraction when welding.

Place the work so that the direction of welding is across, rather than to or from your body.

The electrode holder lead should always be clear of any obstruction so that you can move your arm freely along as the electrode burns down. Some elders prefer to have the welding lead over their shoulder, this allows greater freedom of movement and can reduce the weight from your hand.

Always inspect your welding equipment, welding cables and electrode holder before each use to ensure it's not faulty or worn as you may be at risk of an electric shock.

## MMA process features and benefits

The versatility of the process and the skill level required to learn, basic simplicity of the equipment make the MMA process one of the most common used throughout the world.

The MMA process can be used to weld a wide variety of materials and is normally used in the horizontal position but can be used in vertical or overhead with the correct selection of electrode and current. In addition, it can be used to weld at long distances from the power source subject to the correct cable sizing. The self shielding effect of the electrode coating makes the process suitable for welding in external environments. It is the dominant process used in maintenance and repair industries and is used extensively in structural and fabrication work.

The process is well able to cope with less than ideal material conditions such as dirty or rusty material. Disadvantages of the process are the short welds, slag removal and stop starts which lead to poor weld efficiency which is in the region of 25%. The weld quality is also highly dependent on the skill of the operator and many welding problems can exist.

# GUIDE TO MMA WELDING



Before starting any welding activity ensure that you have suitable eye protection and protective clothing.

Also take the necessary steps to protect any persons within the welding area.

## MMA process tips and guides

### Typical welder set up

1. Electrode holder
2. Work return clamp
3. Work piece
4. Weld material covered by electrode flux or slag
5. Electrode
6. Distance from work to electrode (arc Length)

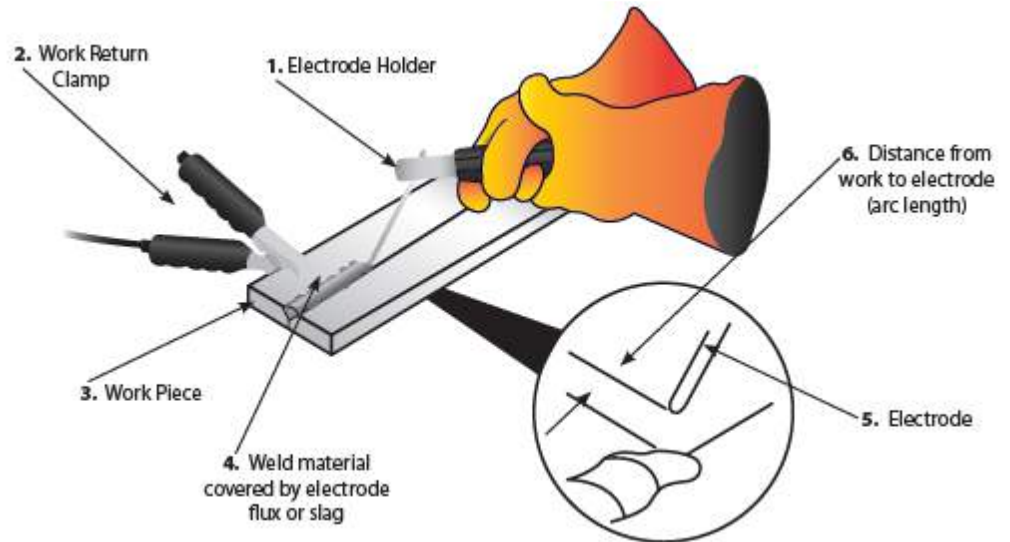

Welding current will flow in the circuit as soon as the electrode contacts the work piece. The welder should always ensure a good connection of the work clamp. The nearer the clamp is placed to the welding area the better.

When the arc is struck the distance between the end of the electrode and the work will determine the arc voltage and also affect the weld characteristic. As a guide the arc length for electrodes up to 3.2mm diameter should be around 1.6mm and over 3.2mm around 3mm.

Upon completion of the weld the welding flux or slag will need to be removed usually with a chipping hammer and wire brush.

### Joint form in MMA

In MMA welding, the common basic joint forms: butt joint, corner joint, lap joint & T joint.

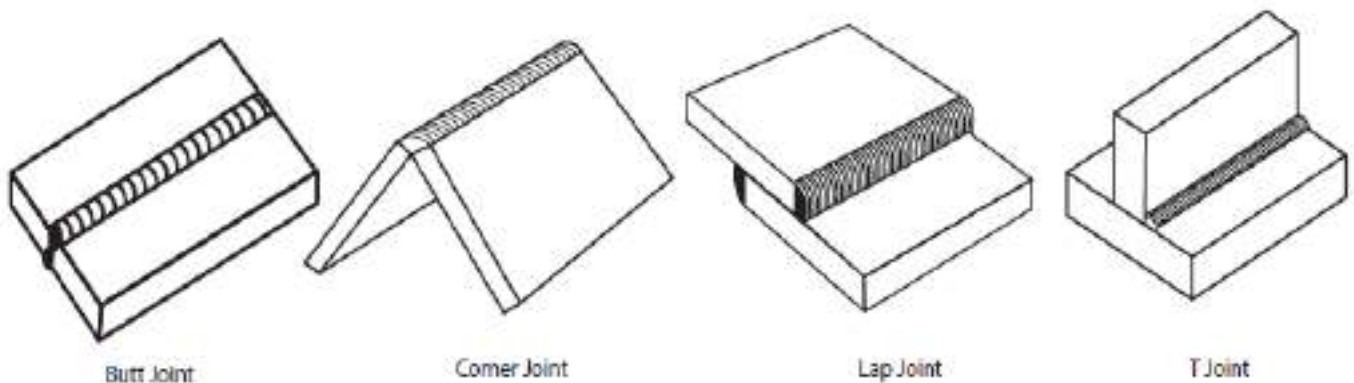

# GUIDE TO MMA WELDING



Before starting any welding activity ensure that you have suitable eye protection and protective clothing.

Also take the necessary steps to protect any persons within the welding area.

## MMA arc striking

**Tap Technique** - Lift the electrode upright and bring it down to strike the work piece. After forming a short circuit, quickly lift up about 2~4mm and arc will be ignited. This method is difficult to master.

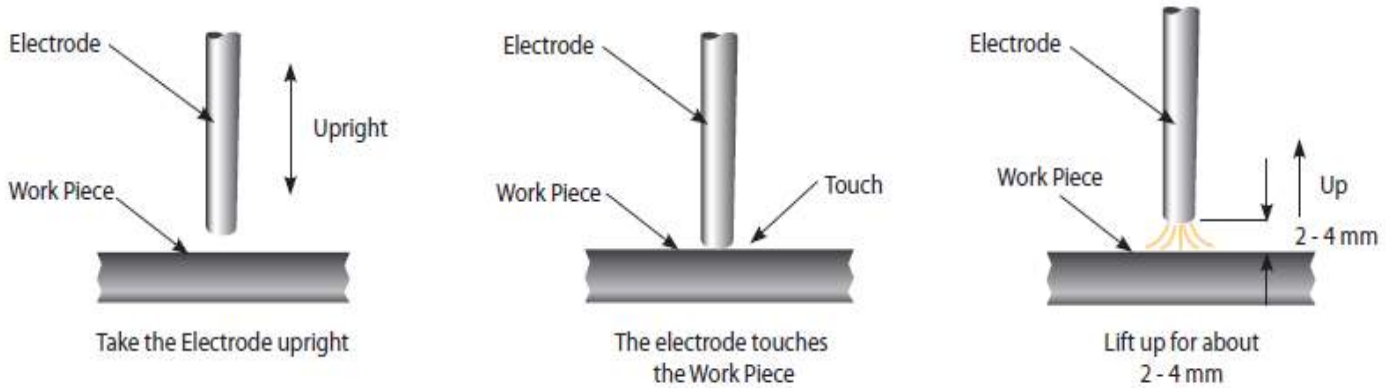

**Scratch technique** - Drag the electrode and scratch the work piece as if striking a match. Scratching the electrode may cause the arc to burn along the scratch path, so care should be taken to scratch in the weld zone. When the arc is struck adopt the correct welding position.

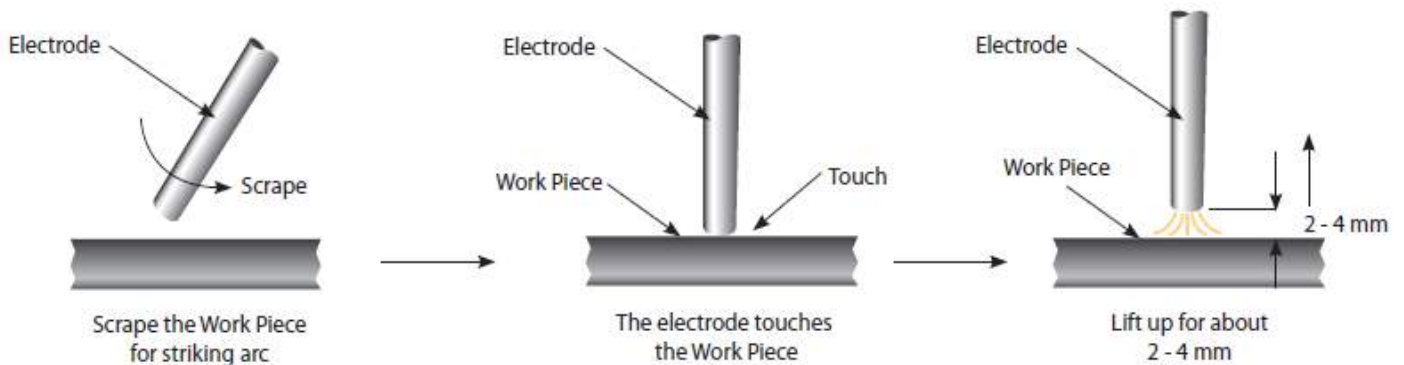

## Electrode positioning

### Horizontal or flat position

The electrode should be positioned at right angles to the plate and inclined in the direction of travel at around 10°-30°.

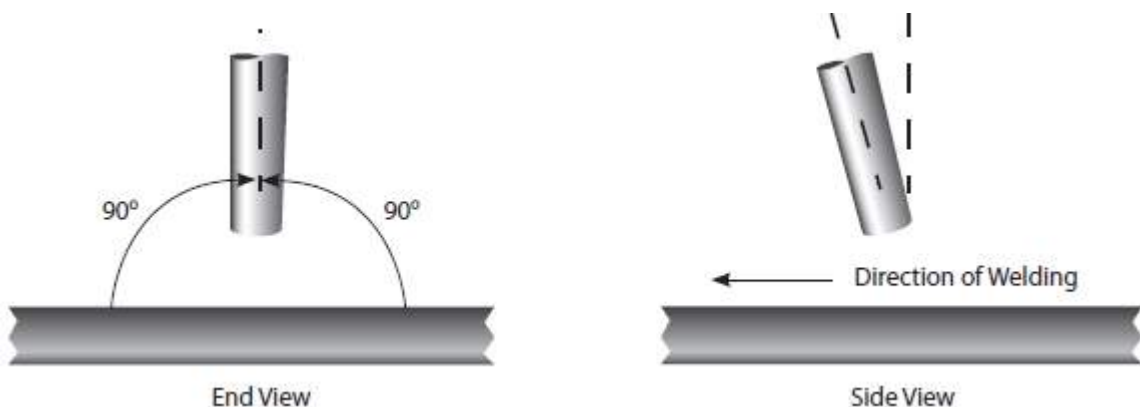

# GUIDE TO MMA WELDING



Before starting any welding activity ensure that you have suitable eye protection and protective clothing.

Also take the necessary steps to protect any persons within the welding area.

## Fillet welding

The electrode should be positioned to split the angle i.e.  $45^\circ$ . Again the electrode should be inclined in the direction of travel at around  $10^\circ$ - $30^\circ$ .

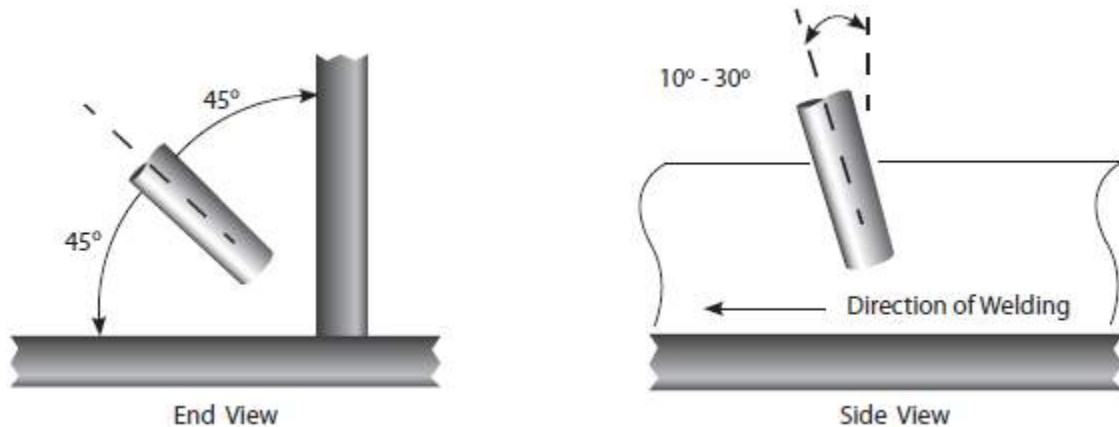

## Manipulation of electrode

In MMA welding there are three motions used at the end of electrode:

1. The electrode feeding to the molten pool along axes
2. The electrode swing right and left
3. The electrode moving in the weld direction

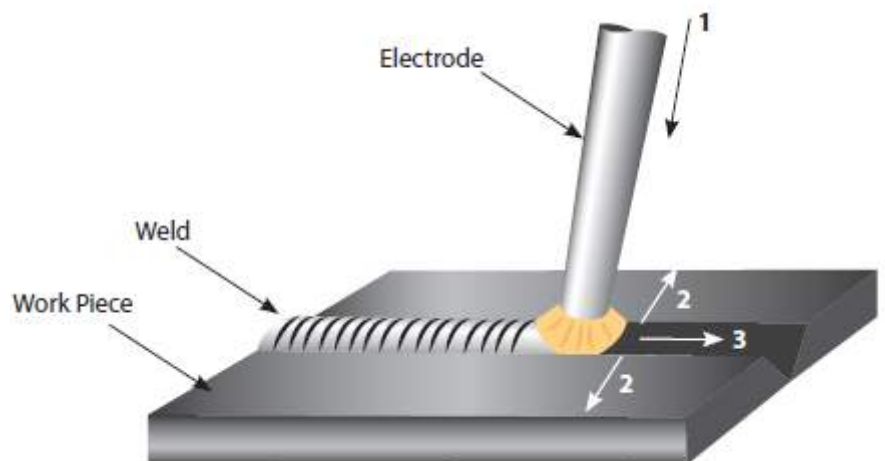

The operator can choose the manipulation of electrode based on welding joint, welding position, electrode spec, welding current and operation skill etc.

## Weld characteristics

A good weld bead should exhibit the following characteristics:

1. Uniform weld bead
2. Good penetration into the base material
3. No overlap
4. Fine spatter level

A poor weld bead should exhibit the following characteristics:

1. Uneven and erratic bead
2. Poor penetration into the base material
3. Bad overlap
4. Excessive spatter levels
5. Weld crater

# MMA WELDING TROUBLESHOOTING



Before starting any welding activity ensure that you have suitable eye protection and protective clothing.

Also take the necessary steps to protect any persons within the welding area.

## Arc welding defects and prevention methods

<u>Defect</u>	<u>Possible cause</u>	<u>Action</u>
Excessive spatter (beads of metal scattered around the weld area)	Amperage too high for the selected electrode	Reduce amperage or utilise larger diameter electrode
	Voltage too high or arc length too long	Reduce arc length or voltage
Uneven and erratic weld bead and direction	Weld bead is inconsistent and misses joint due to operator	Operator training required
Lack of penetration – The weld bead fails to create complete fusion between material to be welded, often surface appears okay but weld depth is shallow	Poor joint preparation	Joint design must allow for full access to the root of the weld
	Insufficient heat input	Material too thick Increase the amperage or increase the electrode size and amperage
	Poor weld technique	Reduce travel speed Ensure the arc is on the leading edge of the weld puddle
Porosity – Small holes or cavities on the surface or within the weld material	Work piece dirty	Remove all contaminant from the material i.e. oil, grease, rust, moisture prior to welding
	Electrode is damp	Replace or dry the electrode
	Arc length is excessive	Reduce the arc length
Excessive penetration – The weld metal is below the surface level of the material and hangs below	Heat input too high	Reduce the amperage or use a smaller electrode and lower amperage
	Poor weld technique	Use correct welding travel speed
Burning through – Holes within the material where no weld exists	Heat input too high	Use lower amperage or smaller electrode Use correct welding travel speed
Poor fusion – Failing of weld material to fuse either with the material to be welded or previous weld beads	Insufficient heat level	Increase the amperage or increase the electrode size and amperage
	Poor welding technique	Joint design must allow for full access to the root of the weld Alter welding technique to ensure penetration such as weaving, arc positioning or stringer bead technique
	Work piece dirty	Remove all contaminant from the material i.e. oil, grease, rust, moisture prior to welding

## OPERATION - LIFT TIG



Before starting any welding activity ensure that you have suitable eye protection and protective clothing as, welding rays, spatter, smoke and high temperatures produced in the process may cause injury to personnel.

Also take the necessary steps to protect any persons within the welding area that may cause injury.

### LIFT TIG welding torch and earth cable connection

Insert the cable plug with the work clamp into the “+” socket on the front panel of the Jasic welding machine and tighten clockwise.

Insert the cable plug of the TIG torch into the “-” socket on the front panel of the Jasic machine and tighten clockwise.

Connect the TIG torch gas hose to the flowmeter outlet that is connected to the regulator which is located on the shield gas cylinder.

Before starting any welding activity, please ensure that you have suitable eye protection and protective clothing. Also take the necessary steps to protect any persons within the welding area.

After connecting the welding leads as detailed right, plug your machine into the mains supply and turn ‘ON’ the machine, the power switch is located at the rear panel of the machine, place it to the "ON" position, the panel indicator will then light up, the fan may start to rotate as the welding machine powers up and the control panel will also light up to indicate that the machine is now ready to use as shown below.

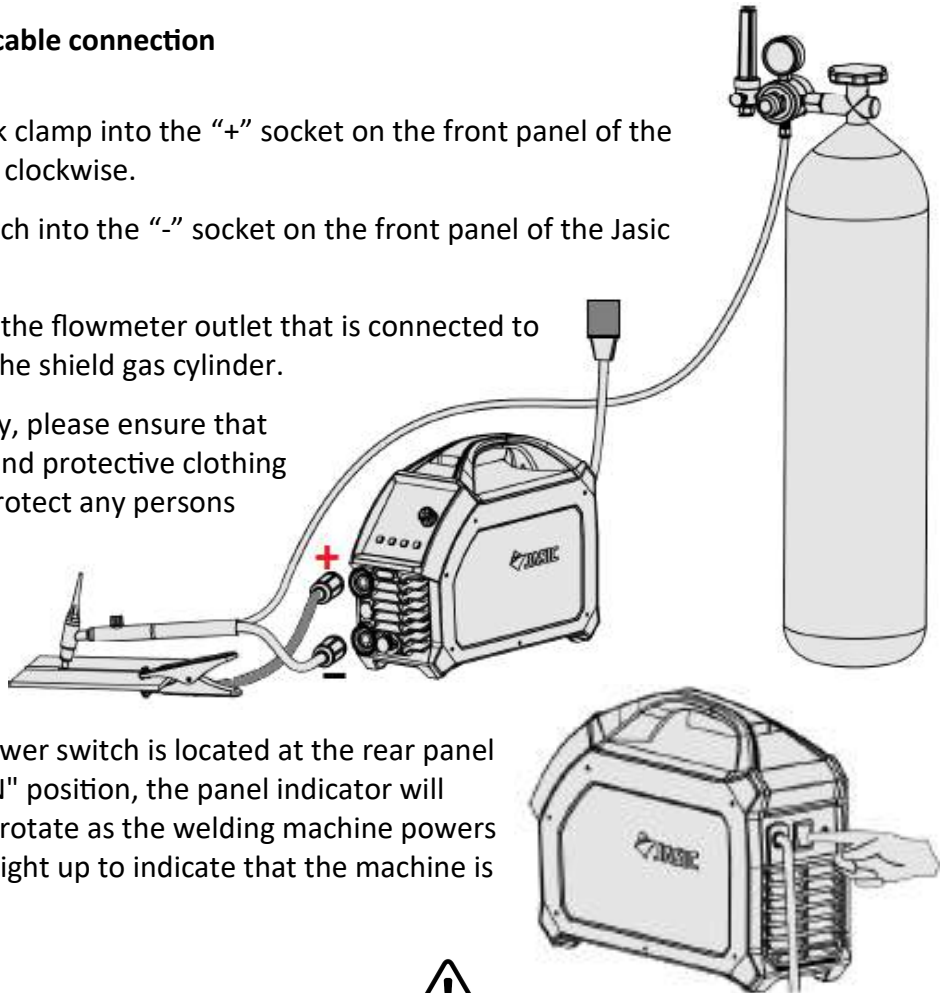

**Caution, there is now output voltage at both output terminals.**

#### PLEASE NOTE:

Some Jasic welding and cutting machines are equipped with smart fan (fan on demand) technology. When the power supply is turned on after a period before welding starts, the fan may automatically stop running. The fan will then run automatically when welding begins and then stay on for a period of time depending on the internal temperature of the welding power source.

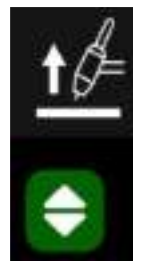

Select Lift TIG by using the selection button until the lift TIG symbol lights up as shown below.

### Set the welding parameters

In LIFT TIG mode, you can adjust and set the welding current parameters using the control dial.

# OPERATION LIFT TIG



Before starting any welding activity ensure that you have suitable eye protection and protective clothing as, welding rays, spatter, smoke and high temperatures produced in the process may cause injury to personnel.

## TIG welding consumables

The consumables of the TIG welding process are filler wires and shield gas.

### Filler wires

Filler wires come in many different material types and usually as cut lengths, unless some automated feeding is required where it will be in reel form. Filler wire is generally fed in by hand.

Always consult the manufacturer's data and welding requirements.

### Gases

Shielding gas is required when welding to keep the weld pool free of oxygen. Whether you are welding mild steel or stainless steel the most commonly used shielding gas used in TIG welding is argon, for more specialised applications an argon helium mix or pure helium maybe used.

### Tungsten Electrode

Choose the appropriate tungsten electrode size and type, welding current and shielding gas flow based on your welding requirements.

As a guide please refer to the following data.

Tungsten Electrode Diameter	Material Thickness	DC – Electrode Negative	Argon Flow Rate
1.0mm ~ 1.6mm	1 ~ 3	15 – 50A	5
		50 – 80A	6
2.4mm	3 ~ 4	80 – 120A	7
		121 ~ 160A	8
3.2mm	4 ~ 6	161 ~ 300A	9
		201 ~ 300A	10

### Arc starting - lift TIG (lift arc)

Not to be confused with scratch start, this arc starting method allows the tungsten to be in direct contact with the work piece first but with minimal current so as not to leave a tungsten deposit when the tungsten is lifted and an arc is established.

With lift TIG, the open circuit voltage (OCV) of the welder folds back to a very low voltage output when the unit senses it has made continuity with the work piece. Once the torch is lifted the unit increases output as the tungsten leaves the surface. This creates little contamination and preserves the point on the tungsten although this is still not a 100% clean process. The tungsten still can get contaminated but lift TIG is still a much better option than scratch starting, for mild and stainless steel although these methods of arc starting are not a good option when welding aluminium.

# OPERATION LIFT TIG



Before starting any welding activity ensure that you have suitable eye protection and protective clothing. Also take the necessary steps to protect any persons within the welding area.

## Arc starting - lift TIG (lift arc)

As described on the previous page, the Jasic ARC range allows the tungsten to be in direct contact with the work piece with minimal current so as not to leave tungsten deposits. LIFT TIG mode has no torch switch operation mode.

Open the gas valve on the TIG welding torch.

Ensure you are in the LIFT TIG mode, set the welding current parameters by using the control knob.

Touch the tungsten electrode to the work piece for less than 2 seconds and then lift away to 2-4mm from the work piece and the welding arc is then established.

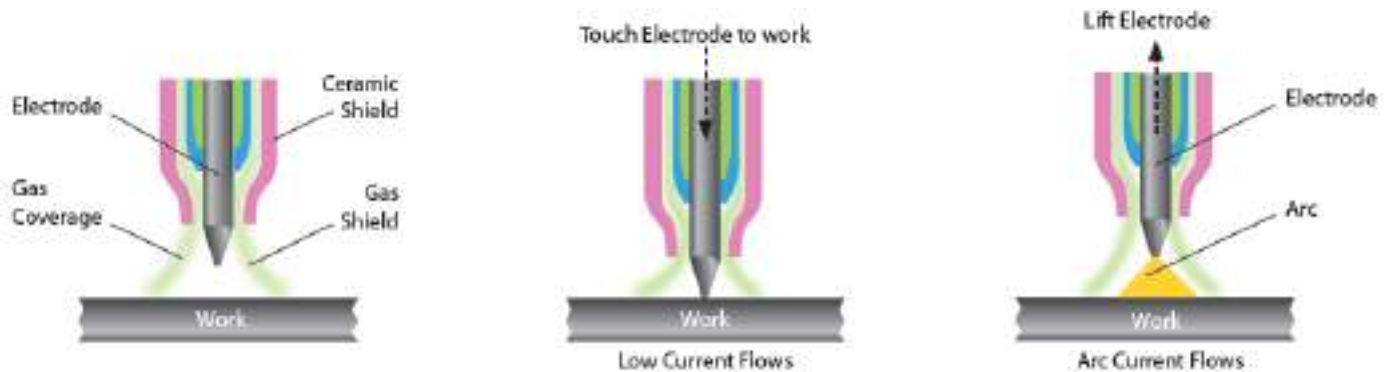

## LIFT TIG process

Once welding is complete pull the torch away to disengage the welding arc but ensure you leave the torch in place to shield the weld with gas for a few seconds and then turn off the gas at the valve on the torch head.

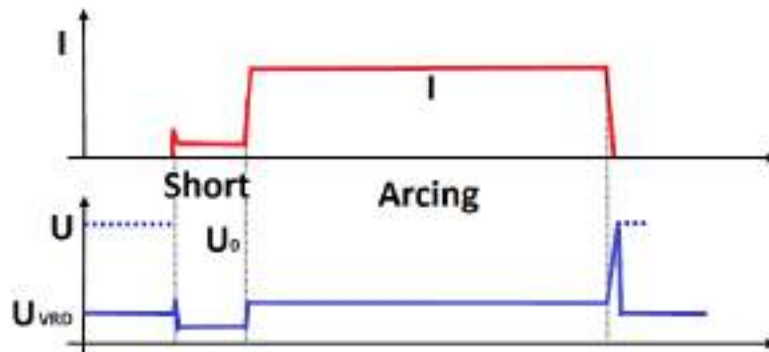

### PLEASE NOTE:

- When starting the arc if the short-circuit time exceeds 2 seconds the welder turns off the output current. Lift the welding torch. Restart the process as above to start the arc again.
- During welding, if there is short circuit between tungsten electrode and the work piece, the welder will immediately reduce the output current; if the short circuit exceeds 1 second, the welder will turn off the output current. If this happens, the arc will need to be restarted as above and the welding torch needs to be lifted to start the arc again.



# GUIDE TO TIG WELDING



Before starting any welding activity ensure that you have suitable eye protection and protective clothing. Also take the necessary steps to protect any persons within the welding area.

## TIG torch body and components

The torch body holds the various welding consumables in place as shown and is covered by either a rigid phenolic or rubberised covering.

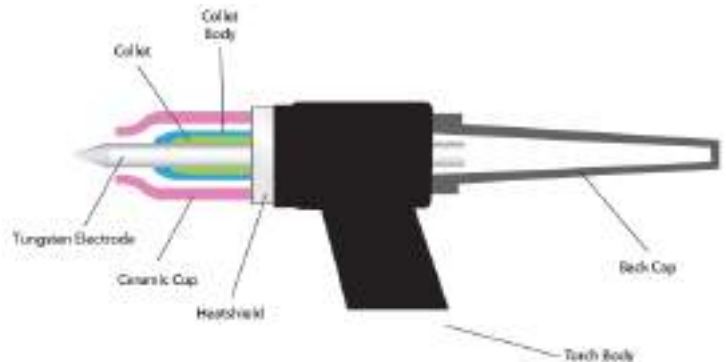

### Collet body

 The collet body screws into the torch body. It is replaceable and is changed to accommodate the different sizes tungsten's and their respective collets.

### Collets

 The welding electrode (tungsten) is held in the torch by the collet. The collet is usually made of copper or a copper alloy. The collet's grip on the electrode is secured when the torch back cap is tightened in place. Good electrical contact between the collet and tungsten electrode is essential for good welding current transfer.

### Gas lens body

 A gas lens is a device that can be used in place of the normal collet body. It screws into the torch body and is used to reduce turbulence in the flow of shield gas and produce a stiff column of undisturbed flow of shielding gas. A gas lens will allow the welder to move the nozzle further away from the joint allowing increased visibility of the arc. A much larger diameter nozzle can be used which will produce a large blanket of shielding gas. This can be very useful in welding material like titanium. The gas lens will also enable the welder to reach joints with limited access such as inside corners.

### Ceramic cups

 Gas cups are made of various types of heat resistant materials in different shapes, diameters and lengths. The cups are either screwed onto the collet body or gas lens body or in some cases pushed in place. Cups can be made of ceramic, metal, metal-jacketed ceramic, glass or other materials. The ceramic type is quite easily broken so take care when putting the torch down.

Gas cups must be large enough to provide adequate shielding gas coverage to the weld pool and surrounding area. A cup of a given size will allow only a given amount of gas to flow before the gas flow becomes disturbed due to the speed of flow. Should this condition exist the size of cup should be increased to allow the flow speed to reduce and once again establish an effective regular shield.

### Back cap

The back cap screws into the rear on the torch head and applies pressure to the back end of the collet which in turn forces up against the collet body, the resulting pressure holds the tungsten in place to ensure it does not move during the welding process.

Back caps are made from a rigid phenolic material and generally come in 3 sizes, short, medium and long.

# GUIDE TO TIG WELDING



Before starting any welding activity ensure that you have suitable eye protection and protective clothing. Also take the necessary steps to protect any persons within the welding area.

## TIG welding electrodes

TIG welding electrodes are a 'non consumable' as it is not melted into the weld pool and great care should be taken not to let the electrode contact the welding pool to avoid weld contamination. This would be referred to as tungsten inclusion and may result in weld failure.

Electrodes will often contain small quantities of metallic oxides which can offer the following benefits:

- Assist in arc starting
- Improve current carrying capacity of the electrode
- Reduce the risk of weld contamination
- Increase electrode life
- Increase arc stability

Oxides used are primarily zirconium, thorium, lanthanum or cerium. These are added usually 1% - 4%.



Tungsten Electrode Colour Chart - DC

Welding Mode	Tungsten Type	Colour
DC or AC/DC	Ceriated 2%	Grey
DC or AC/DC	Lanthanated 1%	Black
DC or AC/DC	Lanthanated 1.5%	Gold
DC or AC/DC	Lanthanated 2%	Blue
DC	Thoriated 1%	Yellow
DC	Thoriated 2%	Red

Tungsten Electrode Current Ranges

Tungsten Electrode Size	DC Current Amp
1.0mm	30 - 60
1.6mm	60 - 115
2.4mm	100 - 165
3.2mm	135 - 200
4.0mm	190 - 280
4.8mm	250 - 340

## Tungsten electrode preparation - DC

When welding at low current the electrode can be ground to a point.

At higher current a small flat on the end of the electrode is preferable as this helps with arc stability.

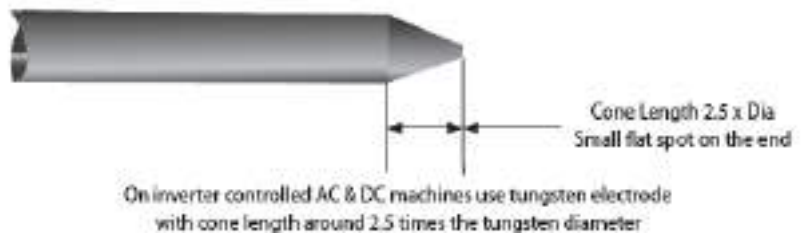

## Electrode grinding

It is important when grinding the electrode to take all necessary precautions such as wearing eye protection and ensuring adequate protection against breathing in any grinding dust.

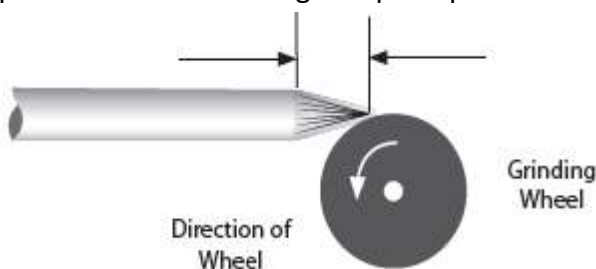

Tungsten electrodes should always be ground lengthwise (as shown) and not in a radial operation. Electrodes ground in a radial operation tend to contribute to arc wander due to the arc transfer from the grinding pattern. Always use a grinder solely for grinding electrodes to avoid contamination.

# GUIDE TO DC TIG WELDING



Before starting any welding activity ensure that you have suitable eye protection and protective clothing. Also take the necessary steps to protect any persons within the welding area.

## DC TIG welding

Direct current welding is when the current flows in one direction only. Compared with AC welding the current once flowing will not go to zero until welding has ended.

The Jasic TIG Series polarity should generally be set up for Direct Current - Electrode Negative (DCEN) as this method of welding can be used for a wide range of materials.

The TIG welding torch is connected to the negative output of the machine and the work return cable to the positive output.

When the arc is established the current flows in the circuit and the heat distribution in the arc is around 33% in the negative side of the arc (the welding torch) and 67% in the positive side of the arc (the work piece). This balance gives deep arc penetration of the arc into the work piece and reduces heat in the electrode.

This reduced heat in the electrode allows more current to be carried by smaller electrodes compared to other polarity connections. This method of connection is often referred to as straight polarity and is the most common connection used in DC welding.

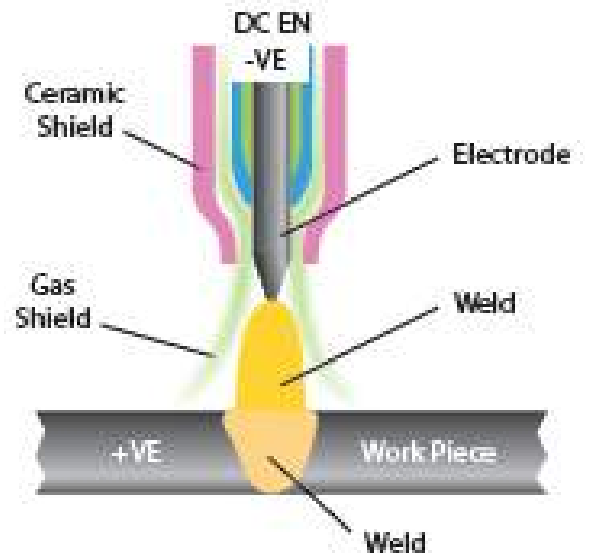

## TIG welding techniques

- Before welding (especially with mild steel) you should ensure all material being welded are clean, as particulates can weaken the weld.
- The torch angle is best kept at 15 ~ 20° (from vertical) away from the direction of travel. This assists with visibility of the weld area and allows easier access for the filler material.
- The filler metal should be fed in at a low angle to help avoid touching the tungsten electrode and contaminating it.
- The TIG welding arc melts the base material and the molten puddle melts the filler rod, it is important you resist the urge to melt the filler material directly into the welding arc.
- For thinner sheet materials, a filler material may not be needed.
- Prepare the tungsten correctly, using a diamond grinding wheel will give you the best results for a sharp point (see page 34).
- For welding stainless steel, be careful of applying too much heat. If the colour is dark grey and looks dirty and heavily oxidized then too much heat has been applied, this could also cause the material to warp. Reducing the amperage and increase travel speed may correct this problem, you could also consider using a smaller diameter filler material, as that will require less energy to melt.

See the following page for a TIG DC welding amperage guide

# GUIDE TO DC TIG WELDING



Before starting any welding activity ensure that you have suitable eye protection and protective clothing. Also take the necessary steps to protect any persons within the welding area.

## Manual DC TIG Welding Amperage Guide- Mild Steel and Stainless Steel

Base Metal Thickness mm	Base Metal Thickness Inch	Tungsten Electrode Diameter	Output Polarity	Filler Wire Diameter (If Required)	Argon Gas Flow Rate (Litres/Min)	Joint Types	Amperage Range
1.6mm	1/16"	1.6mm	DC	1.6mm	5 - 8	Butt	50 - 80
1.6mm	1/16"	1.6mm	DC	1.6mm	5 - 8	Corner	50 - 80
1.6mm	1/16"	1.6mm	DC	1.6mm	5 - 8	Fillet	60 - 90
1.6mm	1/16"	1.6mm	DC	1.6mm	5 - 8	Lap	60 - 90
2.4mm	3/32"	1.6/2.4mm	DC	1.6/2.4mm	5 - 9	Butt	80 - 110
2.4mm	3/32"	1.6/2.4mm	DC	1.6/2.4mm	5 - 9	Corner	80 - 110
2.4mm	3/32"	1.6/2.4mm	DC	1.6/2.4mm	5 - 9	Fillet	90 - 120
2.4mm	3/32"	1.6/2.4mm	DC	1.6/2.4mm	5 - 9	Lap	90 - 120
3.2mm	1/8"	2.4mm	DC	2.4mm	5 - 10	Butt	80 - 120
3.2mm	1/8"	2.4mm	DC	2.4mm	5 - 10	Corner	90 - 120
3.2mm	1/8"	2.4mm	DC	2.4mm	5 - 10	Fillet	100 - 140
3.2mm	1/8"	2.4mm	DC	2.4mm	5 - 10	Lap	100 - 140
4.8mm	3/16"	2.4mm	DC	2.4mm	6 - 11	Butt	120 - 200
4.8mm	3/16"	2.4mm	DC	2.4mm	6 - 11	Corner	150 - 200
4.8mm	3/16"	2.4mm	DC	2.4mm	6 - 11	Fillet	170 - 220
4.8mm	3/16"	2.4mm	DC	2.4mm	6 - 11	Lap	150 - 200
6.4mm	1/4"	2.4mm	DC	3.2mm	7 - 12	Butt	225 - 300
6.4mm	1/4"	2.4mm	DC	3.2mm	7 - 12	Corner	250 - 300
6.4mm	1/4"	2.4mm	DC	3.2mm	7 - 12	Fillet	250 - 320
6.4mm	1/4"	2.4mm	DC	3.2mm	7 - 12	Lap	250 - 320
9.5mm	3/8"	3.2mm	DC	3.2mm	7 - 12	Butt	250 - 360
9.5mm	3/8"	3.2mm	DC	3.2mm	7 - 12	Corner	260 - 360
9.5mm	3/8"	3.2mm	DC	3.2mm	7 - 12	Fillet	270 - 380
9.5mm	3/8"	3.2mm	DC	3.2mm	7 - 12	Lap	230 - 380
12.7mm	1/2"	3.2/4mm	DC	3.2mm	8 - 13	Butt	300 - 400
12.7mm	1/2"	3.2/4mm	DC	3.2mm	8 - 13	Corner	320 - 420
12.7mm	1/2"	3.2/4mm	DC	3.2mm	8 - 13	Fillet	320 - 420
12.7mm	1/2"	3.2/4mm	DC	3.2mm	8 - 13	Lap	320 - 420

### Please Note:

- All above guide settings are approximate and will vary depending on application, prep, passes and type of welding equipment used.
- The welds would need to be tested to ensure they comply to your welding specifications.

# TIG WELDING TROUBLESHOOTING



Before starting any welding activity ensure that you have suitable eye protection and protective clothing. Also take the necessary steps to protect any persons within the welding area.

## TIG welding defects and prevention methods

<u>Defect</u>	<u>Possible cause</u>	<u>Action</u>
Excessive tungsten use	Set up for DCEP	Change to DCEN
	Insufficient shield gas flow	Check for gas restriction and correct flow rates. Check for drafts in the weld area
	Electrode size too small	Select correct size
	Electrode contamination during cooling time	Extend post flow gas time
Porosity/weld contamination	Loose torch or hose fitting	Check and tighten all fitting
	Inadequate shield gas flow	Adjust flow rate - normally 8-12L/m
	Incorrect shield gas	Use correct shield gas
	Gas hose damaged	Check and repair any damaged hoses
	Base material contaminated	Clean material properly
	Incorrect filler material	Check correct filler wire for grade of use
No operation when torch switch is operated	Torch switch or cable faulty	Check the torch switch continuity and repair or replace as required
	ON/OFF switch turned off	Check position of ON/OFF switch
	Mains fuses blown	Check fuses and replace as required
	Fault inside the machine	Call for a repair technician
Low output current	Loose or defective work clamp	Tighten/replace clamp
	Loose cable plug	Check and tighten all plugs
	Power source faulty	Call a repair technician
High frequency will not strike the arc	Weld/power cable open circuit	Check all cables and connections for continuity, especially the torch cables
	No shield gas flowing	Check cylinder contents, regulator and valves, also check the power source
Unstable arc when welding in DC	Tungsten contaminated	Break off contaminated end and regrind the tungsten
	Arc length incorrect	Arc length should be between 3-6mm
	Material contaminated	Clean all base and filler material
	Electrode connected to the wrong polarity	Reconnect to correct polarity
Arc is difficult to start	Incorrect tungsten type	Check and fit correct tungsten
	Incorrect shield gas	Use argon shield gas

# TIG WELDING TROUBLESHOOTING



Before starting any welding activity ensure that you have suitable eye protection and protective clothing. Also take the necessary steps to protect any persons within the welding area.

## TIG welding defects and prevention methods

<u>Defect</u>	<u>Possible cause</u>	<u>Action</u>
Excessive bead build up, poor penetration or poor fusion at the edges of the weld	Weld current too low	Increase the welding amperage Poor material prep
Weld bead flat and too wide or undercut at the weld edge or burning through	Weld current too high	Decrease the welding amperage
Weld bead too small or insufficient penetration	Welding travel speed too fast	Reduce your welding travel speed
Weld bead too wide or excessive bead build up	Welding travel speed too slow	Increase your welding travel speed
Uneven leg length in fillet joint	Wrong placement of filler rod	Re-position filler rod
Tungsten melts or oxidises when welding arc is made	TIG torch lead connected to + Little or no gas flow to weld pool  Gas cylinder or hoses contain impurities The tungsten is too small for the weld current TIG/MMA selector set to MMA	Connect to - polarity Check gas apparatus as well as torch and hoses for breaks or restrictions Change gas cylinder and blow out torch and gas hoses Increase the size of the tungsten  Ensure you have the power source set to TIG function

# TIG TORCH TROUBLESHOOTING

## TIG welding defects and prevention methods

The TIG torch used for lift TIG welding comprises of several items which ensure current flow and arc shielding from the atmosphere.

Regular maintenance of the welding torch is one of the most important measures to ensure its normal operation and extend lifespan.

In order to ensure normal maintenance, the wearing parts of the torch should have spares, including the electrode holder, nozzle, sealing ring, insulating washer, etc.

Common faults of the welding torch include overheating, gas leakage, water leakage, poor gas protection, electric leakage, nozzle burn out, and cracking. The causes of these faults and troubleshooting methods are as shown in the following table:

Symptom	Reasons	Troubleshooting
The welding torch is overheated	The welding torch capacity is too small	Replace with a welding torch with large capacity
	The collet fails to clamp the tungsten electrode	Replace the collet or back cap
Gas leakage	The sealing ring is worn	Replace the sealing ring
	The gas connection thread is loose	Tighten it
	The gas inlet pipe joint is damaged or not fastened	Cut off the damaged joint, reconnect and tighten the replaced gas inlet pipe or wrap up the damaged area
	The gas inlet pipe has been damaged by heat or aging	Replace the gas inlet pipe
Operator receiving a shock from the torch	The torch head is wet due to leakage or other reasons	Find the cause of water leakage, and fully dry the torch head
	The torch head is damaged or the live metal part is exposed	Replace the torch head or wrap the exposed electrified metal part with adhesive tape
Poor gas flow or porosity in the weld	The welding torch is leaking	Locate the leakage
	The nozzle diameter is too small	Replace with a nozzle of larger diameter
	The nozzle is damaged or cracked	Replace with a new nozzle
	The gas circuit in the welding torch is blocked	Blow the circuit with compressed air to clear the blockage
	The gas screen has been damaged or lost during disassembly and assembly	Replace with a new gas screen
	The argon gas is impure	Replace with standard argon gas
	The gas flow is too large or small	Adjust the gas flow properly
Arc started between the collet/collet holder or the tungsten electrode/torch head	The collet and tungsten electrode have poor contact, or arc is started when the tungsten electrode contacts the base metal	Replace the collet or repair
	The collet and welding torch have poor contact	Connect the collet and welding torch properly

## MAINTENANCE



The following operation requires sufficient professional knowledge on electric aspects and comprehensive safety knowledge. Make sure the input cable of the machine is disconnected from the electricity supply and wait for 5 minutes before removing the machine covers.

In order to guarantee that the arc welding machine works efficiently and in safety, it must be maintained regularly. Operators should understand the maintenance methods and means of arc welding machine operation. This guide should enable customers to carry out simple examination and safeguarding by oneself, try to reduce the fault rate and repair times of the arc welding machine, so as to lengthen service life of arc welding machines.

<u>Period</u>	<u>Maintenance item</u>
Daily examination	Check the condition of the machine, mains cables, welding cables and connections. Check for any warnings LEDs and machine operation.
Monthly examination	Disconnect from the mains supply and wait for at least 5 minutes before removing the cover. Check internal connections and tighten if required. Clean the inside of the machine with a soft brush and vacuum cleaner. Take care not to remove any cables or cause damage to components. Ensure that ventilation grills are clear. Carefully replace the covers and test the unit. <b>This work should be carried out by a suitably qualified competent person.</b>
Yearly examination	Carry out an annual service to include a safety check in accordance with the manufacturers standard (EN 60974-1). <b>This work should be carried out by a suitably qualified competent person.</b>

## TROUBLESHOOTING

Before arc welding machines are dispatched from the factory, they have already been checked thoroughly. The machine should not be tampered with or altered. Maintenance must be carried out carefully. If any wire becomes loose or is misplaced, it maybe potentially dangerous to user!

<u>Description of fault</u>	<u>Possible cause</u>	<u>Action</u>
The welding arc cannot be established	Power switch has not been switched ON Incoming mains power supply is not ON Possible internal power failure	- Switch ON power switch - Check incoming power switch for correct operation and supply - Have a technician check the machine and mains power supply
Difficult arc ignition	Low arc current	- Increase the arc current setting - Check condition of the MMA welding leads
Overheat LED lit	Machine operated outside duty cycle Fan not working	- Allow the machine to cool and the unit will reset automatically - Have a technician check for obstructions blocking the fan
Over current LED lit	Mains supply problem	- Have a technician check the mains supply



## TROUBLESHOOTING - ERROR CODES



The following operation requires sufficient professional knowledge on electric aspects and comprehensive safety knowledge. Make sure the input cable of the machine is disconnected from the electricity supply and wait for 5 minutes before removing any machine covers.

The control display is also used for providing error messages to the user, if an error message is displayed, the power source may only function to a limited capacity and the cause of the error should be checked as soon as possible.

The below is a list of error codes for the Jasic EVO ET200 and ET-200P welding machines.

Error Code	Error Code Description	Possible Cause	Check
E10	Overcurrent protection	The output is at maximum capacity current of machine	Turn the machine off and back on again. If overcurrent protection alarm is still active, contact your suppliers approved technician.
E31	Undervoltage protection	The input mains voltage is too low	Turn the machine off and back on again. If the alarm continues, check the input voltage. If the input voltage is within specification and the alarm persists, contact your suppliers approved technician.
E32	Overvoltage protection	The input mains voltage is too high	Turn the machine off and back on again. If the alarm continues, check the input voltage. If the input voltage is within specification and the alarm persists, contact your suppliers approved technician.
E34	Undervoltage protection	Under voltage in inverter circuit	Turn the machine off and back on again. If the alarm continues, check the input voltage. If the input voltage is within specification and the alarm persists, contact your suppliers approved technician.
E61	Overheating	An over temperature signal received from the Inverter IGBT circuit	Do not turn off the machine, wait for a while and after the thermal error goes off then you can continue welding. While error code is ON, machine cannot cut. Ensure cooling fans are operational. Decrease duty cycle welding activity.
E62	Overheating	An over temperature signal received from the output rectifier circuit	Do not turn off the machine, wait for a while and after the thermal error goes off then you can continue welding. While error code is ON, machine cannot cut. Ensure cooling fans are operational. Decrease duty cycle welding activity.
	Abnormal VRD	VRD voltage is too high or too low	Turn the machine off and back on again. If the fault VRD alarm persists, contact your suppliers approved technician.

## **WEEE disposal**

The equipment is manufactured with materials which do not contain any toxic or poisonous materials dangerous to the operator.

When the equipment is scrapped, it should be dismantled separating components according to the type of materials.

Do not dispose of the equipment with normal waste. The European Directive 2002/96/EC and United Kingdom's Directive The Waste Electrical and Electronic Equipment (WEEE) regulations 2013 states that electrical equipment that has reached its end of life must be collected separately and returned to an environmentally compatible recycling facility.

Jasic has a relevant recycling system which is compliant and registered in the UK with the environment agency. Our registration reference is WEEMM3813AA.

In order to comply with WEEE regulations outside the UK you should contact your supplier.

## **RoHS Compliance Declaration**

We herewith confirm, that the above mentioned product does not contain any of the restricted substances as listed in EU Directive 2011/65/EU and the UK directive ROHS Regulations 2012 in concentrations above the limits as specified therein.

### **Disclaimer:**

Please note that this confirmation is given to the best of our present knowledge and belief.

Nothing herein represents and/or may be interpreted as warranty within the meaning of the applicable warranty law.

# UKCA Declaration of Conformity



## UK DECLARATION OF CONFORMITY

The manufacturer or its legal representative Wilkinson Star Limited declares that the equipment listed described below is designed and produced according to the following UK directives:

Electrical equipment (Safety) regulations 2016	2016 No 1101
Electromagnetic compatibility regulations 2016	2016 No 1091
The restriction of the use of certain hazardous substances in electrical and electronic equipment regulations 2012	2012 No 3052
Requirements for welding equipment pursuant to the eco-design for energy related products and	UK SI 2021/745

And inspected in compliance with the following harmonised standards

- BS EN 60974-1:2018 + A1:2019
- BS EN 60974-10:2014 + A1:2015
- BS EN 62822-1:2018

Any alteration or change to these machines by any unauthorised person makes this declaration invalid

### WILKINSON STAR MODEL

EA-160  
EA-200

### JASIC MODEL

Arc 160 PFC Z2S22  
Arc 200 PFC Z2S42

#### Authorised Representative

Wilkinson Star Limited  
Shield Drive, Wardley Industrial Estate  
Worsley, Salford M28 2WD  
Tel +44 161 793 8127

Signature

Dr John A Wilkinson CBE

Position Chairman

Date 23/03/2023



#### Manufacturer

Shenzhen Jasic Technology Co Ltd  
No3 Qinglan, 1st Road  
Pingshan District  
Shenzhen, China

Signature

Shenzhen Jasic Technology Co Ltd

Position

Date



Company Stamp

*Handwritten signature and date: Mar 23 / 2023*



# EC DECLARATION OF CONFORMITY



## EU DECLARATION OF CONFORMITY

The manufacturer or its legal representative Wilkinson Star Limited declares that the equipment listed described below is designed and produced according to the following EU directives:

Low voltage directive (LVD)	2014/35/EU
Electromagnetic compatibility directive (EMC)	2014/30/EU
RoHS2	2011/65/EU
Annex 11 of RoHS2	2015/863
Eco design requirements for welding equipment pursuant 2009/125/EC	2019/1784

And inspected in compliance with the following harmonised standards

EN 60974-1:2018 + A1:2019  
EN 60974-10:2014 + A1:2015  
EN 62822-1:2018

**Any alteration or change to these machines by any unauthorised person makes this declaration invalid**

### WILKINSON STAR MODEL

EA-160  
EA-200

### JASIC MODEL

Arc 160 PFC Z2522  
Arc 200 PFC Z2542

#### Authorised Representative

Wilkinson Star Limited  
Shield Drive, Wardley Industrial Estate  
Worsley, Salford M28 2WD  
Tel +44 161 793 8127

Signature

John Wilkinson OBE

Position Chairman

Date



#### Manufacturer

Shenzhen Jasic Technology Co Ltd  
No3 Qinglan, 1st Road  
Pingshan District  
Shenzhen, China

Signature

Shenzhen Jasic Technology Co Ltd

Position

Date



Company Stamp

CE

## STATEMENT OF WARRANTY

All new JASIC EVO2.0 welding, plasma cutters and multi-process machines are sold through our partner Wilkinson Star Limited within the United Kingdom and Ireland shall be warrantied to the original owner, non transferable, against failure due to defective materials or production.

The warranty period is 5 years following the date of purchase and we recommend you register your product online within 28 days of purchase.

The original invoice is documentation for the standard warranty period. The warranty period is based on a single shift pattern.

Defective units shall be repaired or replaced by the company at our workshop. The company may opt to refund the purchase price (less any costs and depreciation due to use and wear).

The company reserves the right to alter the warranty conditions at any time with effect for the future.

A prerequisite for the full warranty is that products are operated in accordance with the operating instructions supplied, observing the relevant installation and any legal requirements recommendations and guidelines and carrying out the maintenance instructions shown in the operator manual. This should be carried out by a suitably qualified competent person.

Warranty claims will only be accepted from authorised Jasic distributors and in the unlikely event of a problem this should be reported to the technical support team to review the claim.

The customer has no claim to loan or replacement products whilst repairs are being performed.

The following falls outside the scope of the warranty:

- Defects due to natural wear and tear
- Failure to observe the operating and maintenance instructions
- Connection to an incorrect or faulty mains supply
- Overloading during use
- Any modifications that are made to the product without the prior written consent
- Software errors due incorrect operation
- Any repairs that are carried out using non-approved spare parts
- Any transport or storage damage
- Direct or indirect damage as well as any loss of earnings are not covered under the warranty
- External damage such as fire or damage due to natural causes e.g. flooding
- Warranty repairs carried out by non-authorized Jasic distributors.

NOTE: Under the terms of the warranty, welding torches, their consumable parts, wire feed unit drive rolls and guide tubes, work return cables and clamps, electrode holders, connection and extension cables, mains and control leads, plugs, wheels, coolant etc. are covered with a 3 month warranty.

Jasic shall in no event be responsible for any third party expenses or expenses/costs or any indirect or consequential expenses/costs.

Jasic will submit an invoice for any repair work performed outside the scope of the warranty. A quotation for any non warranty will be raised prior to any repairs being carried out.

The decision about repair or replacement of the defective part(s) is made by Jasic. The replaced part(s) remain(s) Jasic property.

Warranty extends only to the machine, its accessories and parts contained inside. No other warranty is expressed or implied. No warranty is expressed or implied in regards to the fitness of the product for any particular application or use.

If in our judgment you fail, or we suspect that you have failed, to comply with any term or provision of the product warranty terms, we reserve the right to deny you access to our services (or any part thereof).

For further information on Jasic product warranty terms and product warranty registration please visit:

**[www.jasic.co.uk/warranty-information](http://www.jasic.co.uk/warranty-information)**

**[www.jasic.co.uk/warranty-registration](http://www.jasic.co.uk/warranty-registration)**

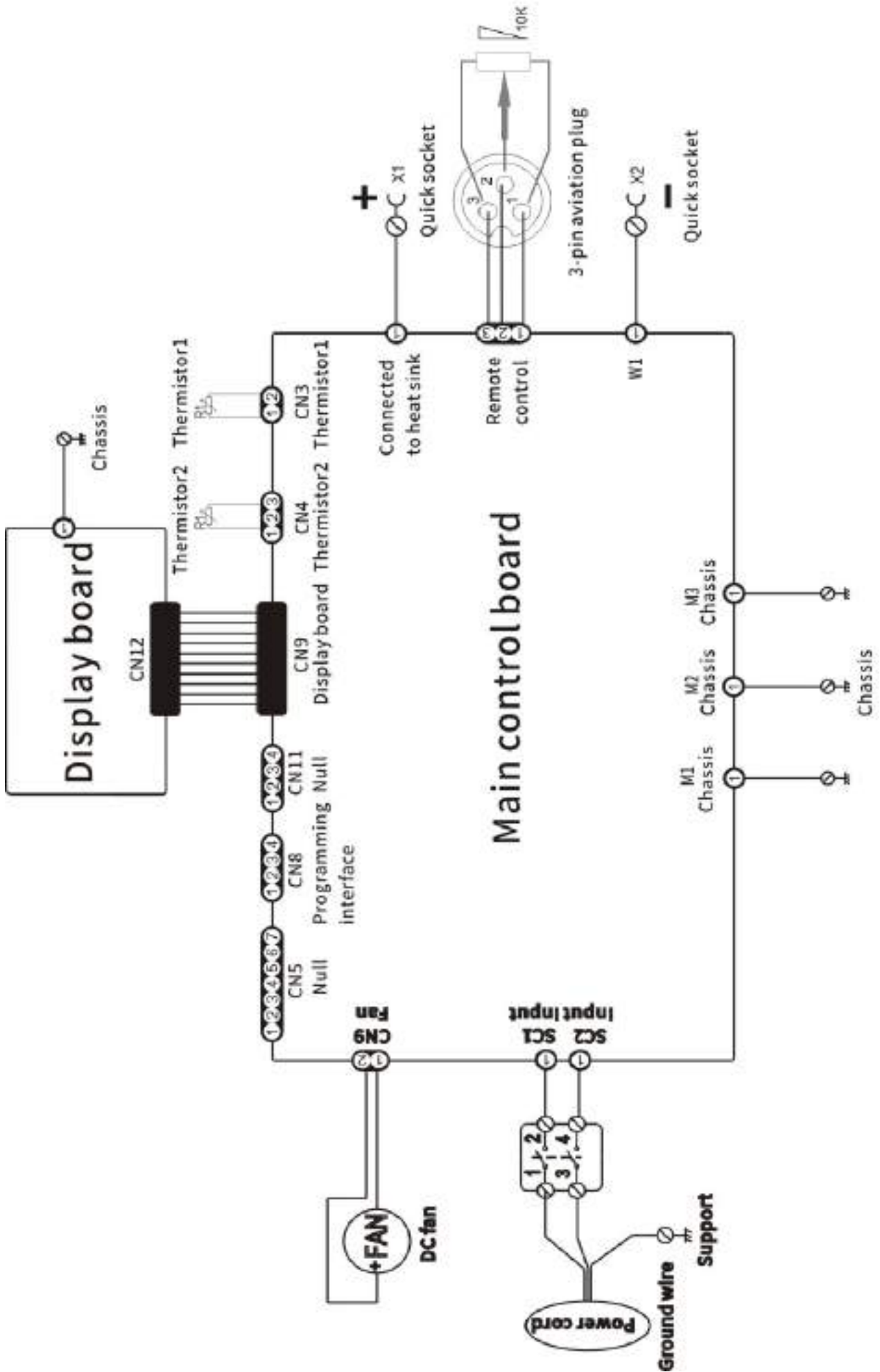

# SCHEMATIC



## OPTIONS AND ACCESSORIES

Part Number	Description
WP17V-12-2DL	'Valve' 17V TIG Torch, 12.5ft, 2 Piece c/w CP3550 Plug & 2mt Gas Hose
WP26V-12-2DL	'Valve' 26V TIG Torch, 12.5ft, 2 Piece c/w CP3550 Plug & 2mt Gas Hose
WCS25-3WEL	Welding Cable Set (MMA) 3m
WC-2-03LD	Electrode Holder and lead 3m
EC-2-03LD	Work Return Lead and Clamp 3m
CP3550	Cable Plug 35-50mm
JH-HDX	Jasic HD True Colour Auto Darkening Welding Helmet
HRC-04	Wired hand held remote current control (3 pin)
HRC-03	Mini Wireless hand held remote current control
TS5	MMA Transceiver (used with HRC-02)

## Optional Remote Control Devices

Type	Name	Model	Wireless Receiver	Welding Mode	Image
Wired	Wired handheld remote Control	HRC-04	N/A	MMA/TIG	
Wireless	Mini Wireless handheld remote control	HRC-03	Yes	MMA	
	Wireless Transceiver	TS-5	Yes	-	-

### Remote control function:

**HRC-03** - Adjusts welding current in MMA and Lift TIG mode

**HRC-04** - Adjust welding current in MMA mode and Lift TIG mode









**Wilkinson Star Limited**

Shield Drive  
Wardley Industrial Estate  
Worsley  
Manchester  
UK  
M28 2WD

**+44(0)161 793 8127**



[Jasic.co.uk](http://Jasic.co.uk)

 **JASIC**® | Passionate About Your Welding

[www.jasic.co.uk](http://www.jasic.co.uk)

April 2023 Issue 1